

Characterization of directly-imaged exoplanets at high spectral resolution: Coupling SPHERE and CRIRES+

Arthur Vigan

Laboratoire d'Astrophysique de Marseille (LAM)
Centre National de la Recherche Scientifique (CNRS)

LAM: A. Vigan, G. Otten, E. Muslimov, M. El Morsy, M. Lopez, A. Viret, A. Costille, K. Dohlen, J.-L. Beuzit, M. Houllé, E. Choquet, J.-F. Sauvage, N. Tchoubaklian, Y. Charles / **University of Göttingen:** A. Reiners, H. Anwand / **ESO:** U. Seemann, M. Kasper, R. Dorn, G. Zins, J. Paufique / **University of Exeter:** M. Phillips, I. Baraffe / **IPAG:** D. Mouillet, A. Carlotti / **Laboratoire Lagrange:** M. N'Diaye, R. Pourcelot, D. Mary / **LESIA:** A. Boccaletti, B. Charnay
+ ESO Paranal support: A. Smette, L. Pallanca, L. Blanco, et al.



Direct imaging of exoplanets

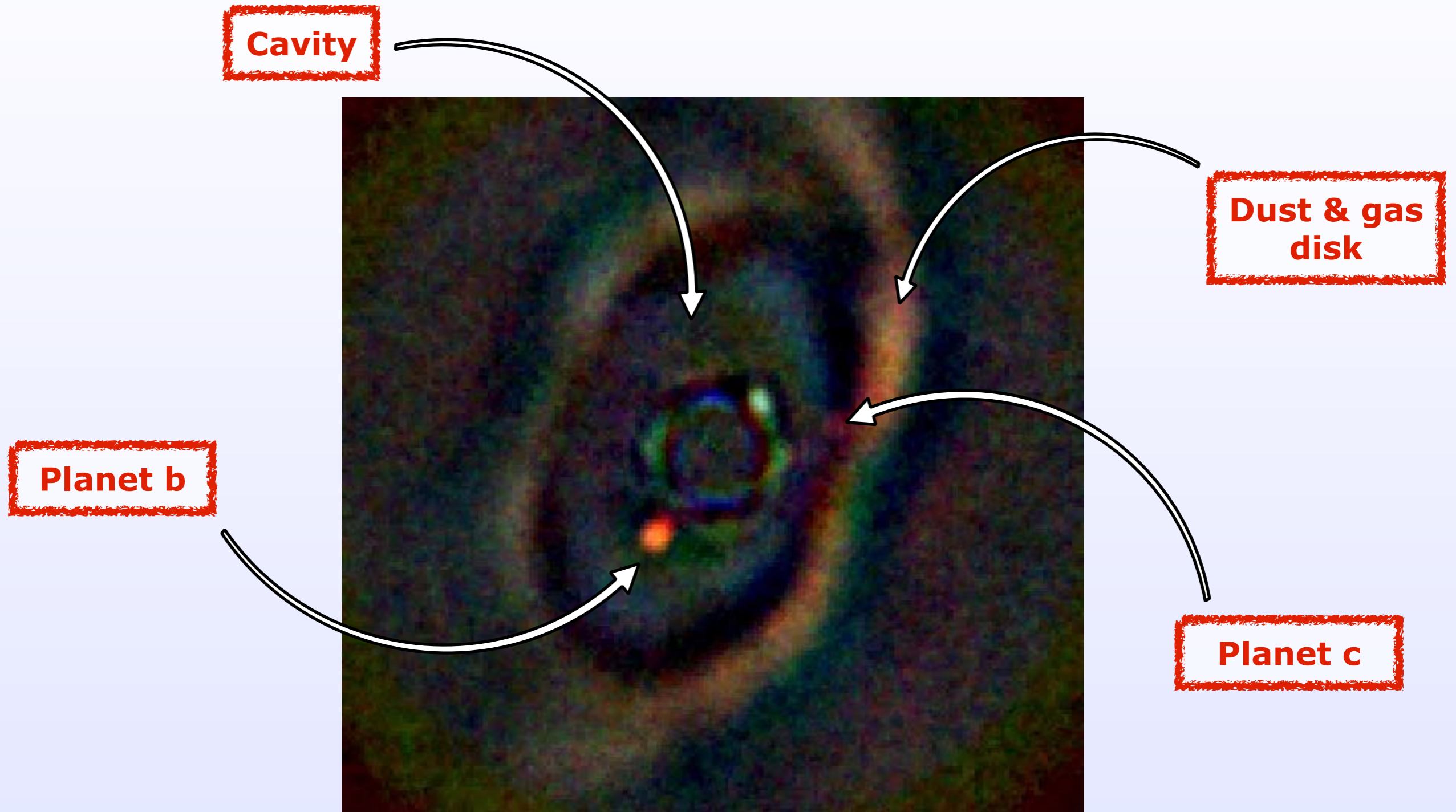

PDS 70 - Keppler et al. (2018)

Direct imaging of exoplanets

Physical units

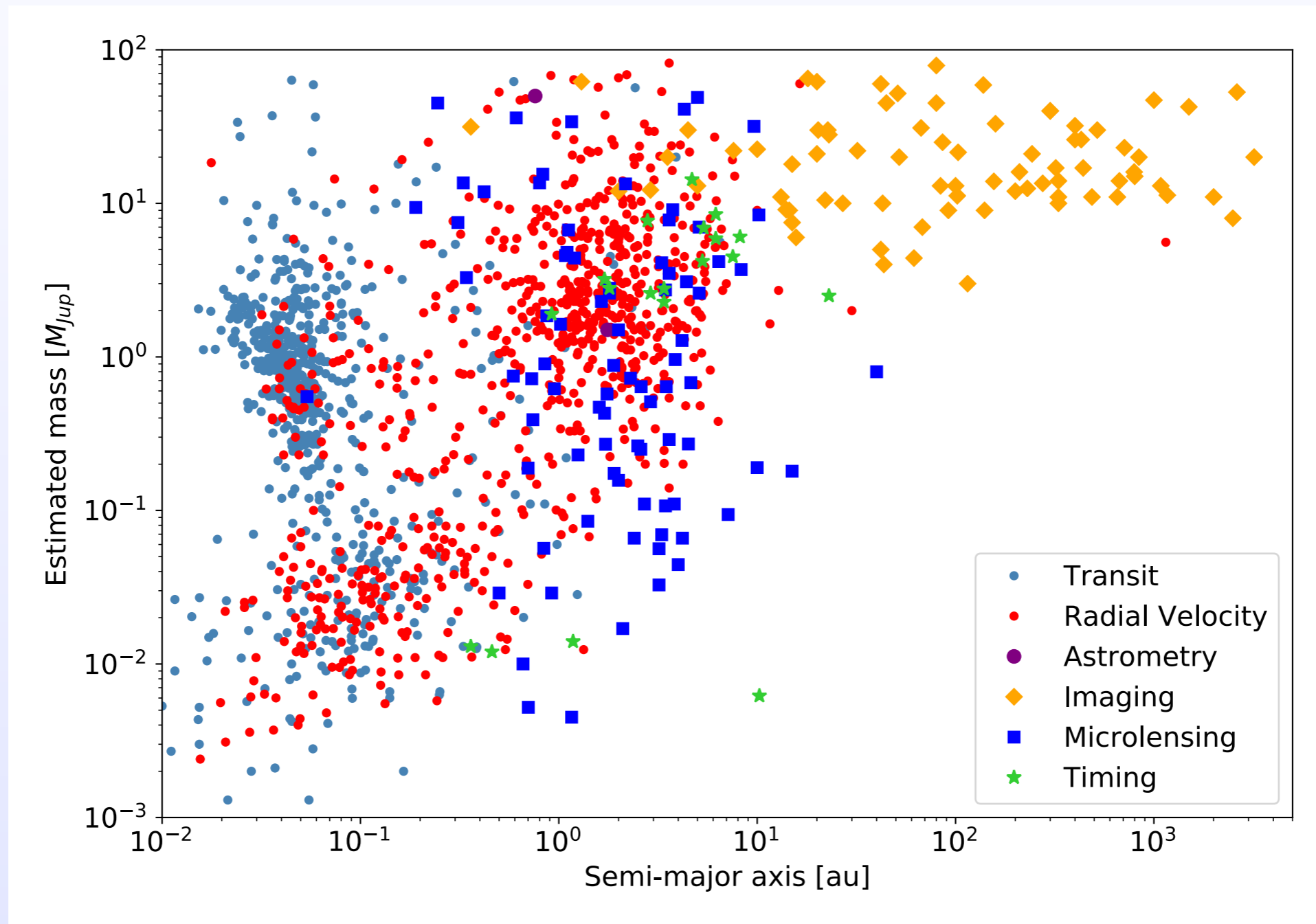

Direct imaging of exoplanets

Observables

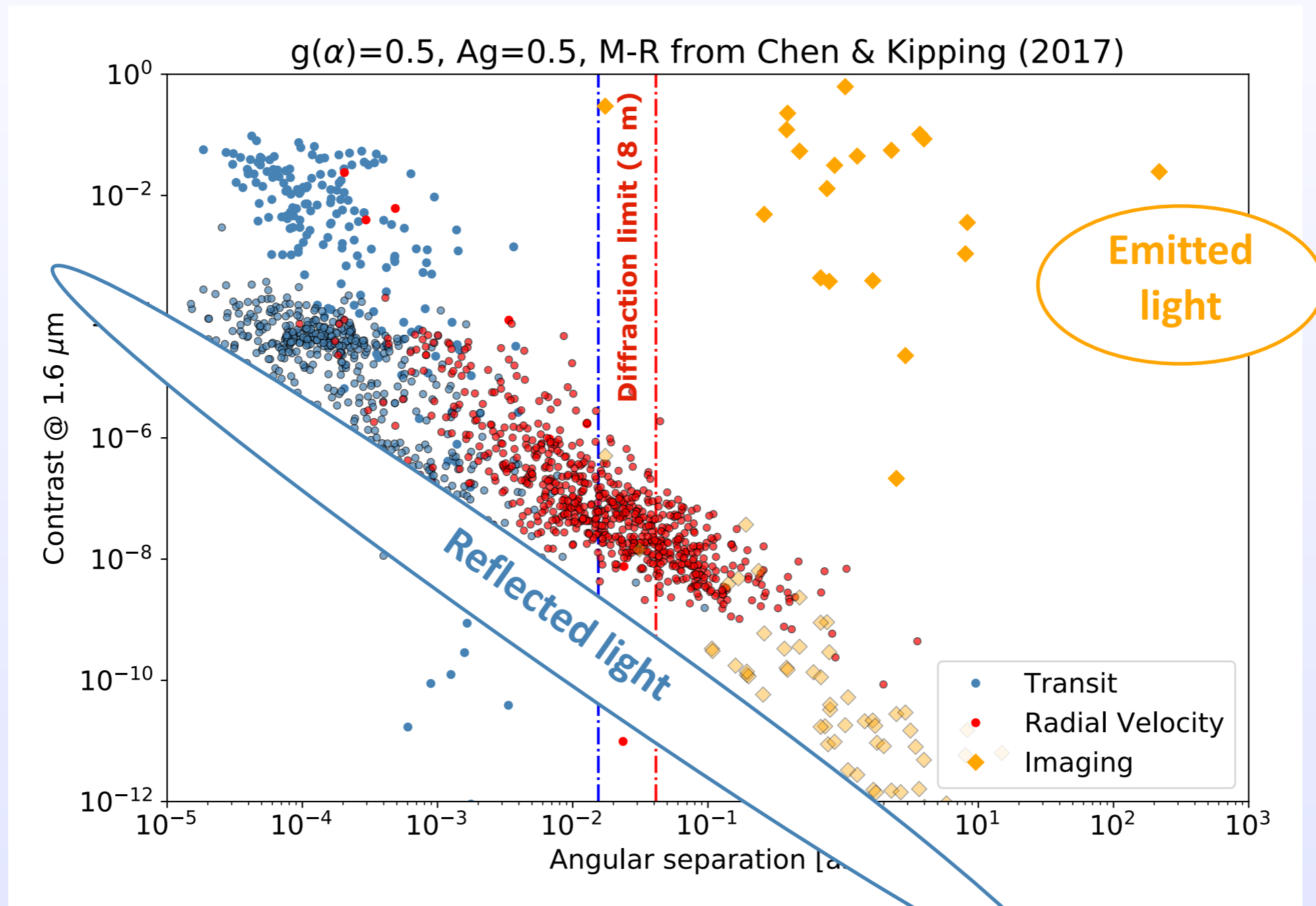

Direct imaging of exoplanets

High-angular resolution

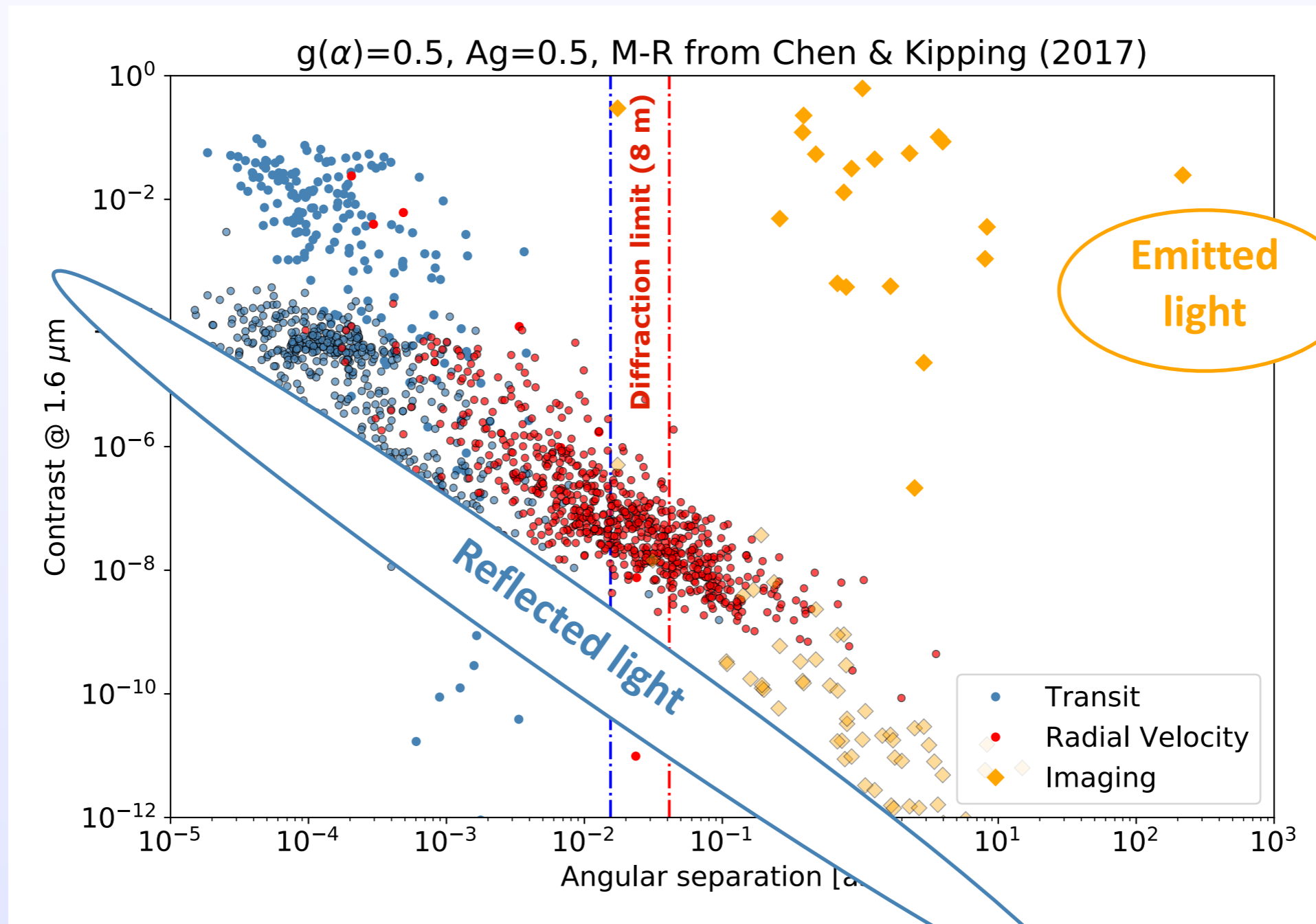

High-contrast

SPHERE @ VLT/UT3



VLT/SPHERE

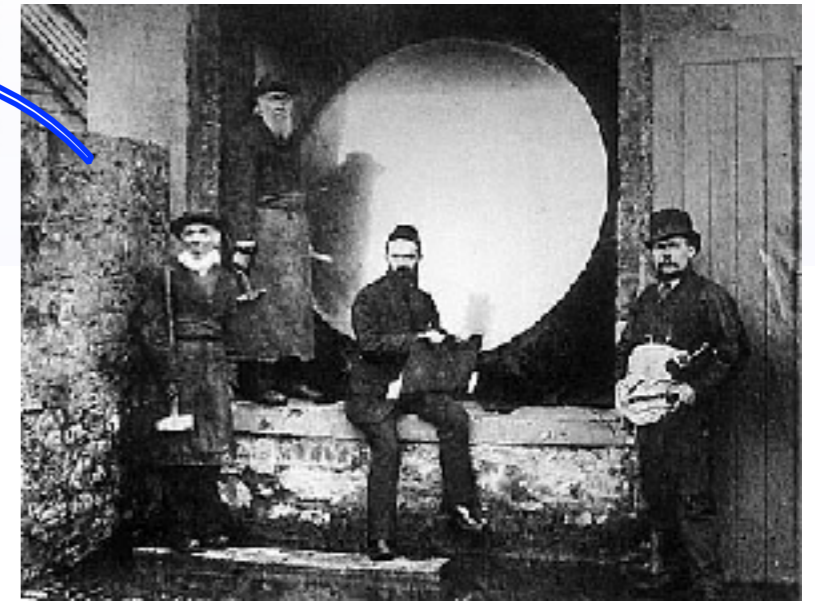

8 meter VLT mirror

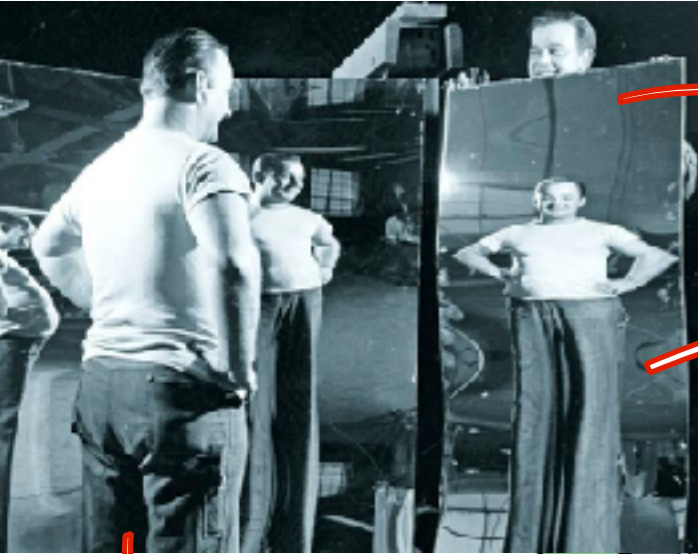

SAXO ExAO system
40x40 DM
1500Hz SHWFS

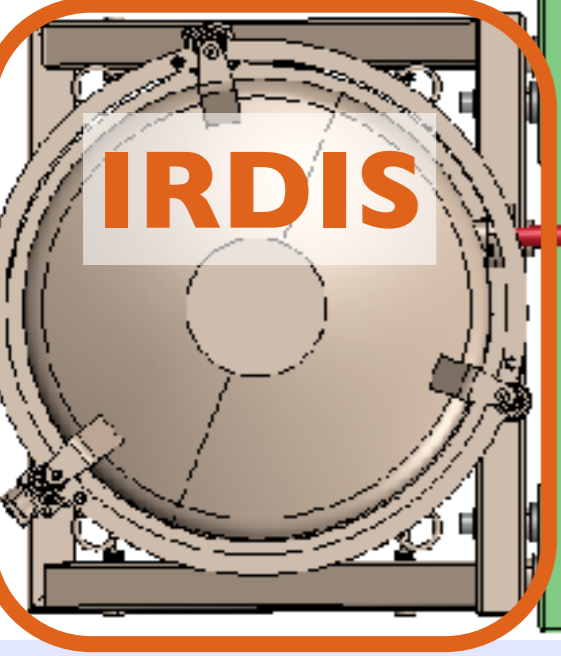

IRDIS

Arthur Vigan - ExEP Technolog

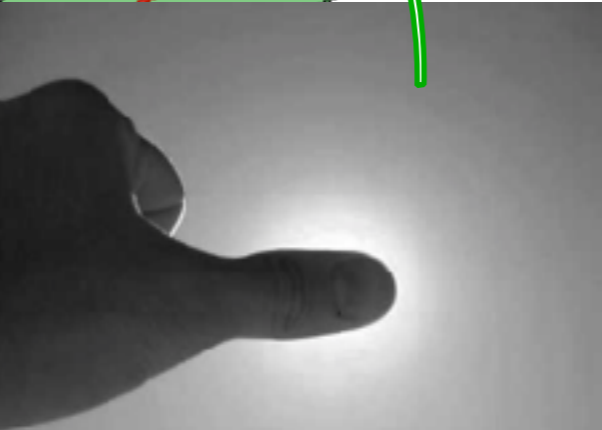

Apodized-pupil Lyot coronagraph

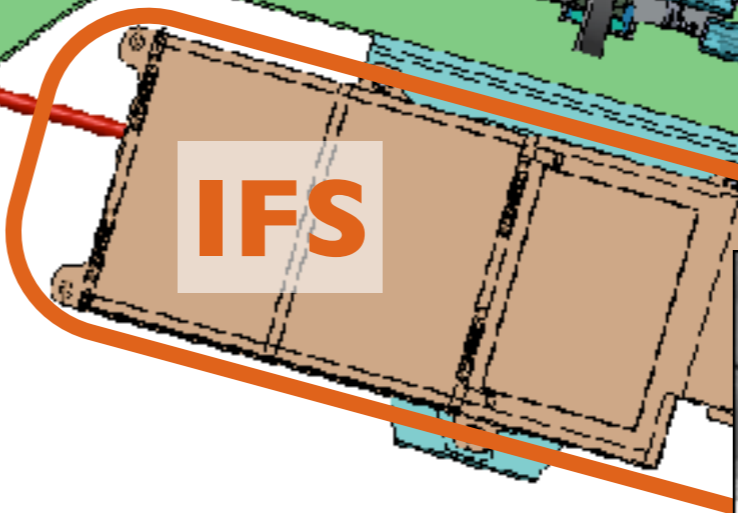

IFS

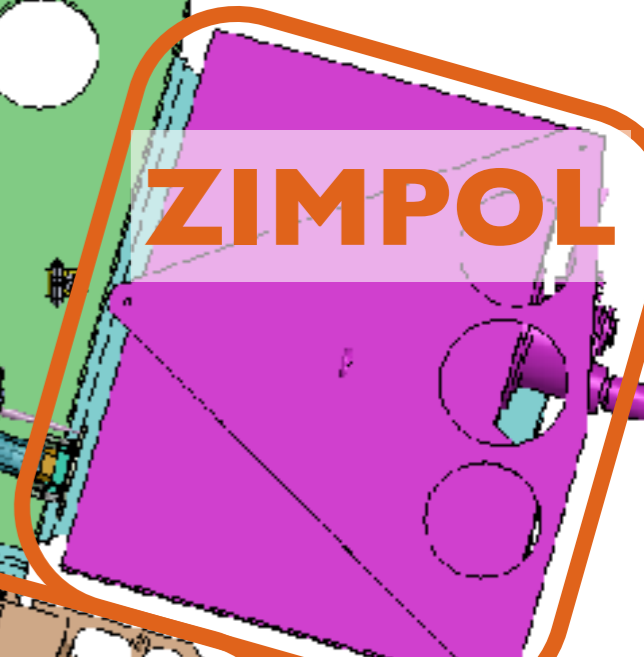

ZIMPOL

Direct imaging recipe

Seeing-limited PSF

✗ Adaptive optics
✗ Coronagraph

Diffraction-limited PSF

✓ Adaptive optics
✗ Coronagraph

Diffraction-limited PSF

✓ Adaptive optics
✗ Coronagraph

Coronagraphic image

✓ Adaptive optics
✓ Coronagraph

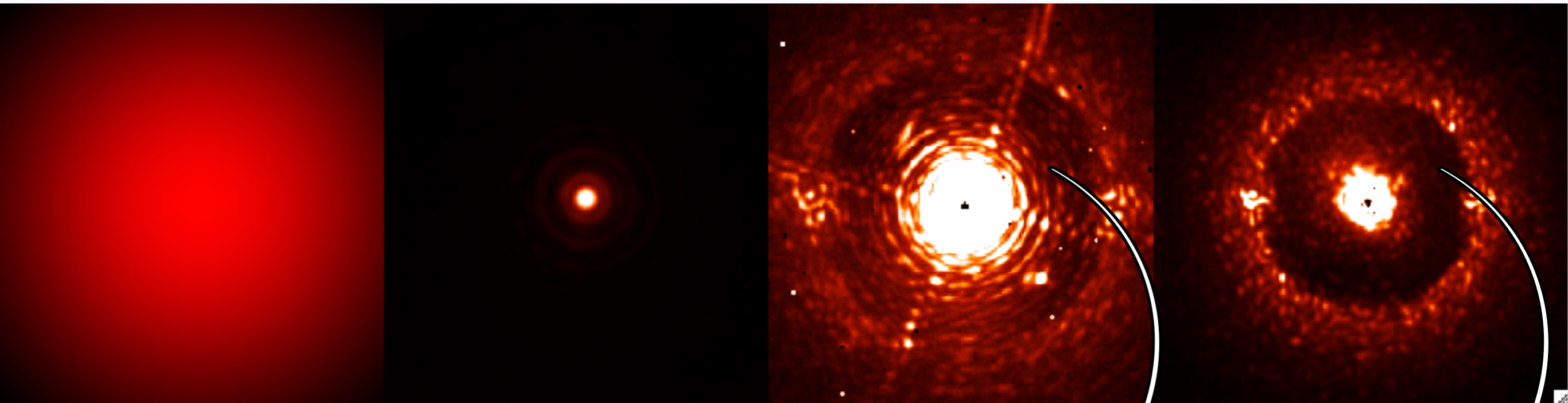

Diffraction limited
within $20 \lambda/D$

10^{-4} - 10^{-5} contrast
in dark zone

$\sim 10^{-5}$ - 10^{-6} contrast down to $0.2''$

Enough to detect young giant exoplanets
of a few Jupiter masses

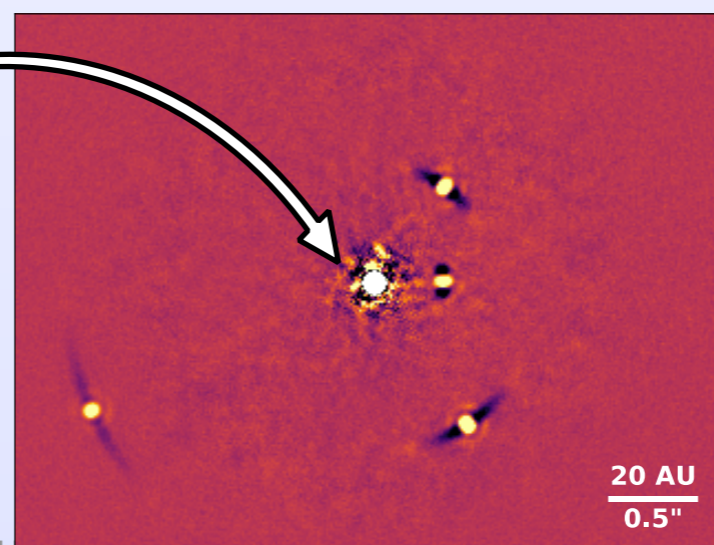

post-processing

SPHERE and GPI detections

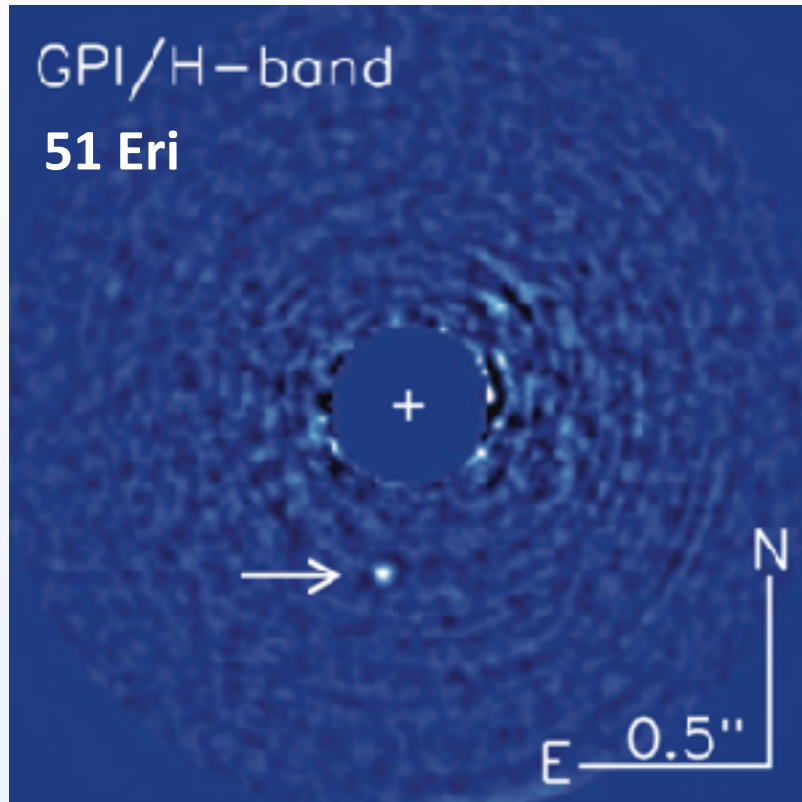

Macintosh et al. 2015

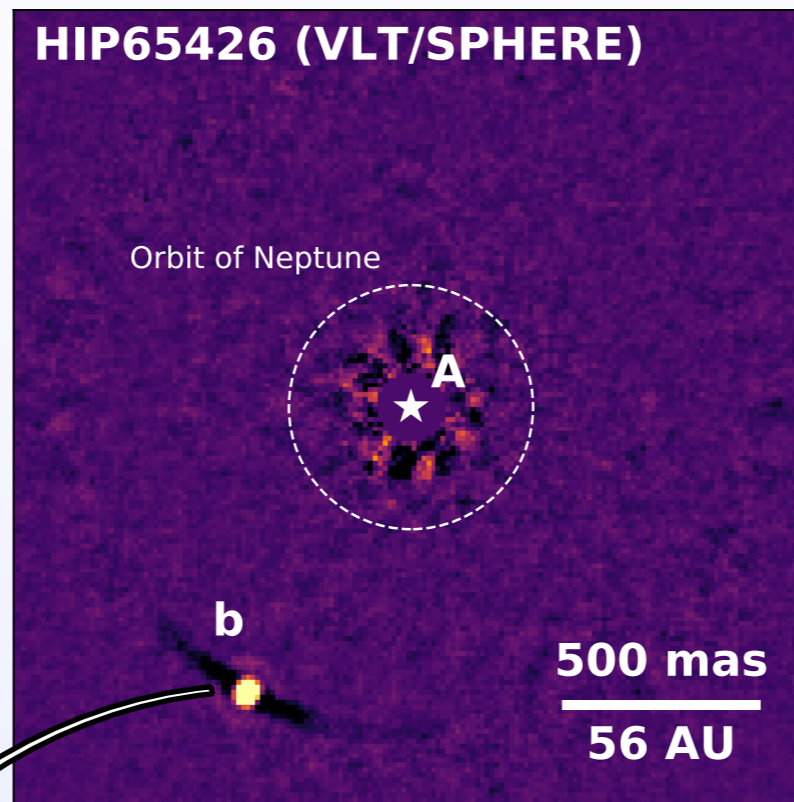

Chauvin et al. 2017

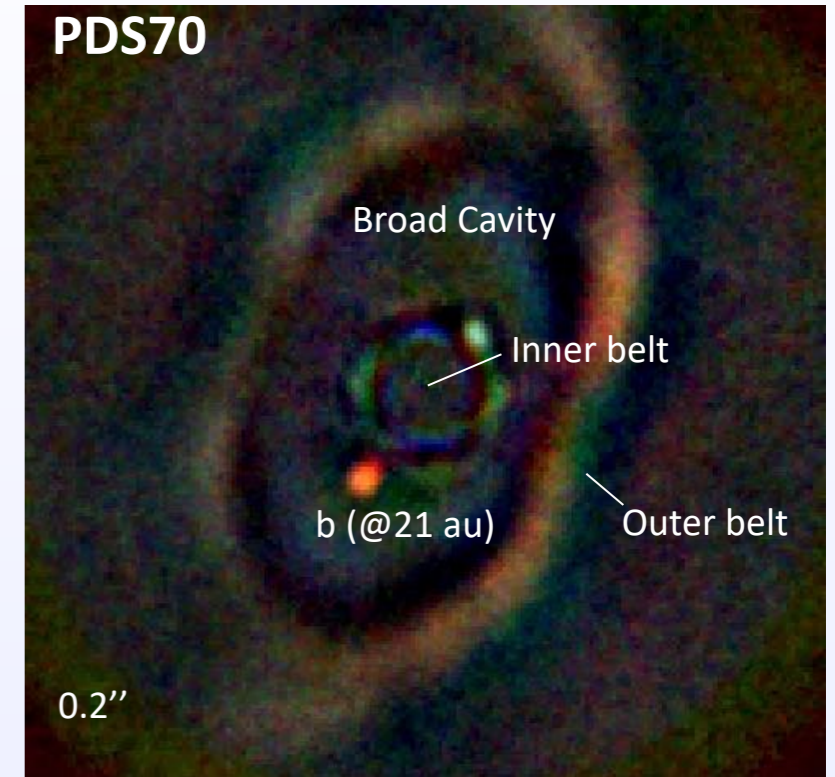

Keppler et al. 2018

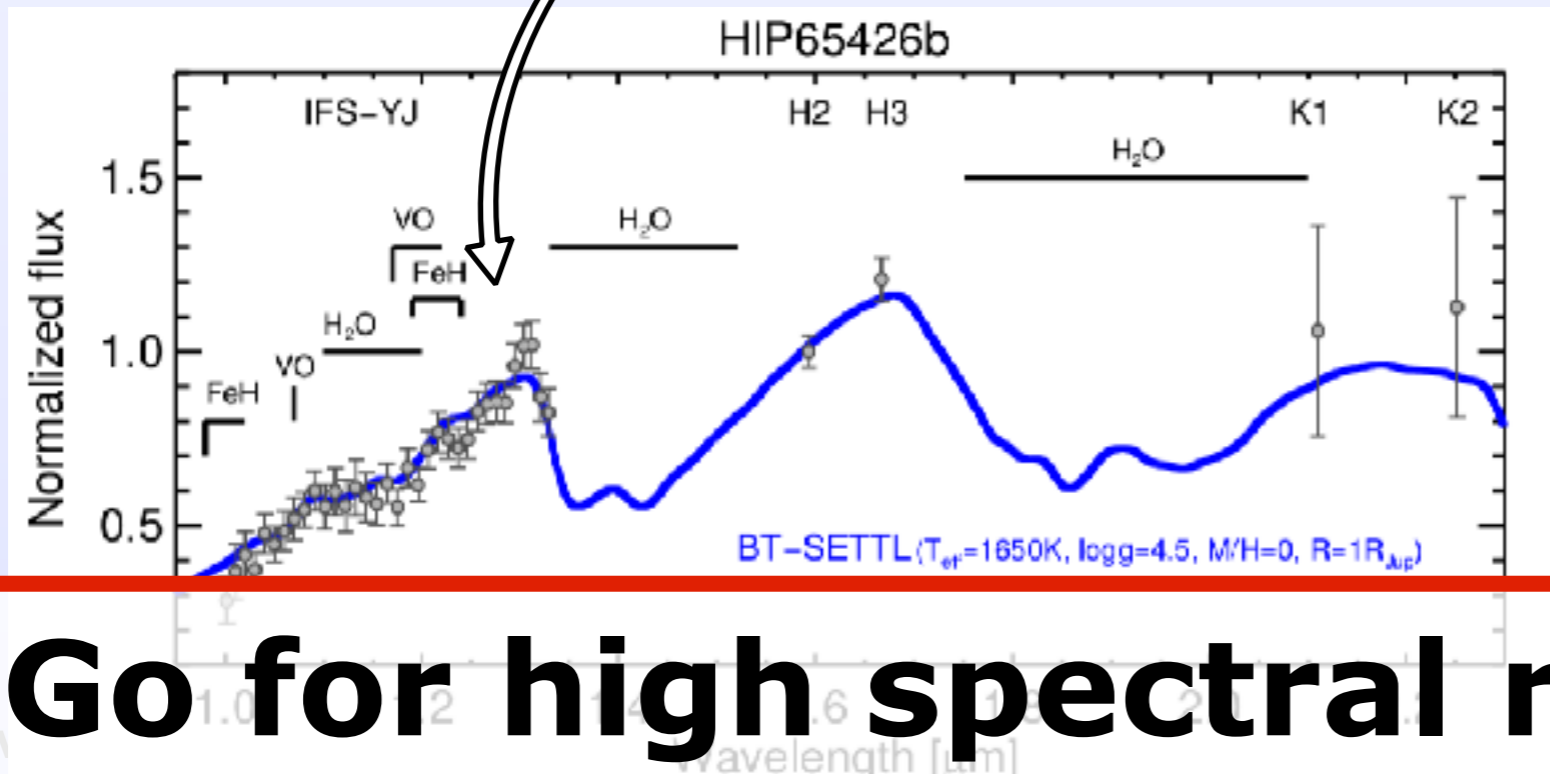

Very low resolution spectroscopy!

→ First order characterisation

Go for high spectral resolution!

Detection boost at high-spectral resolution

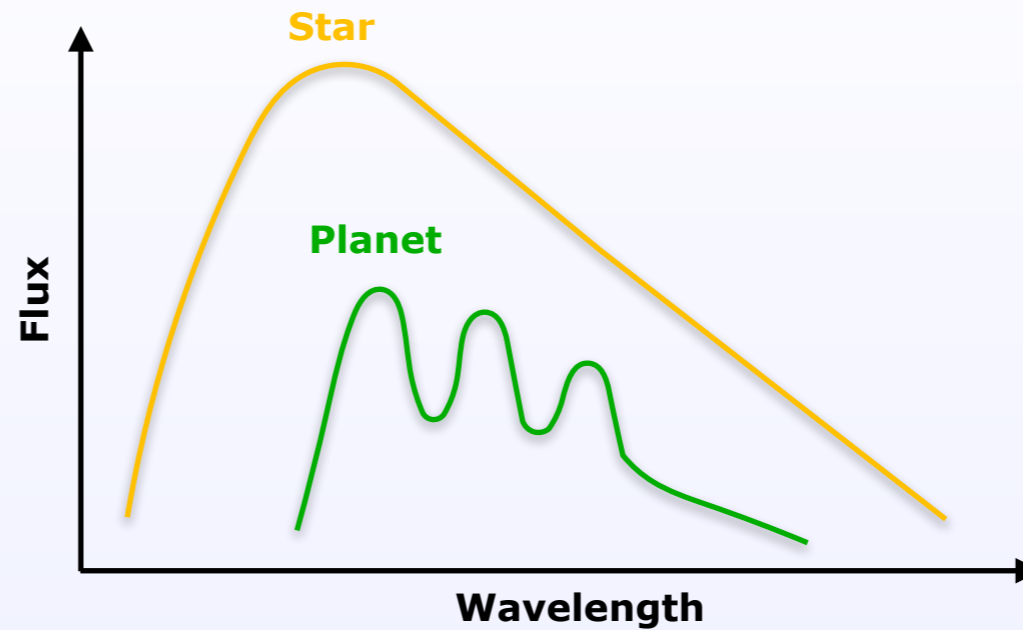
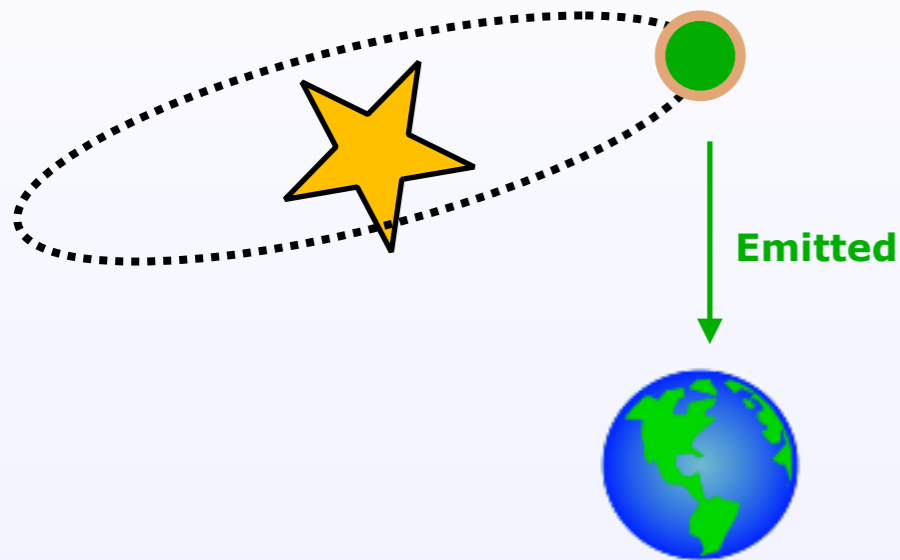

Cross-correlation function

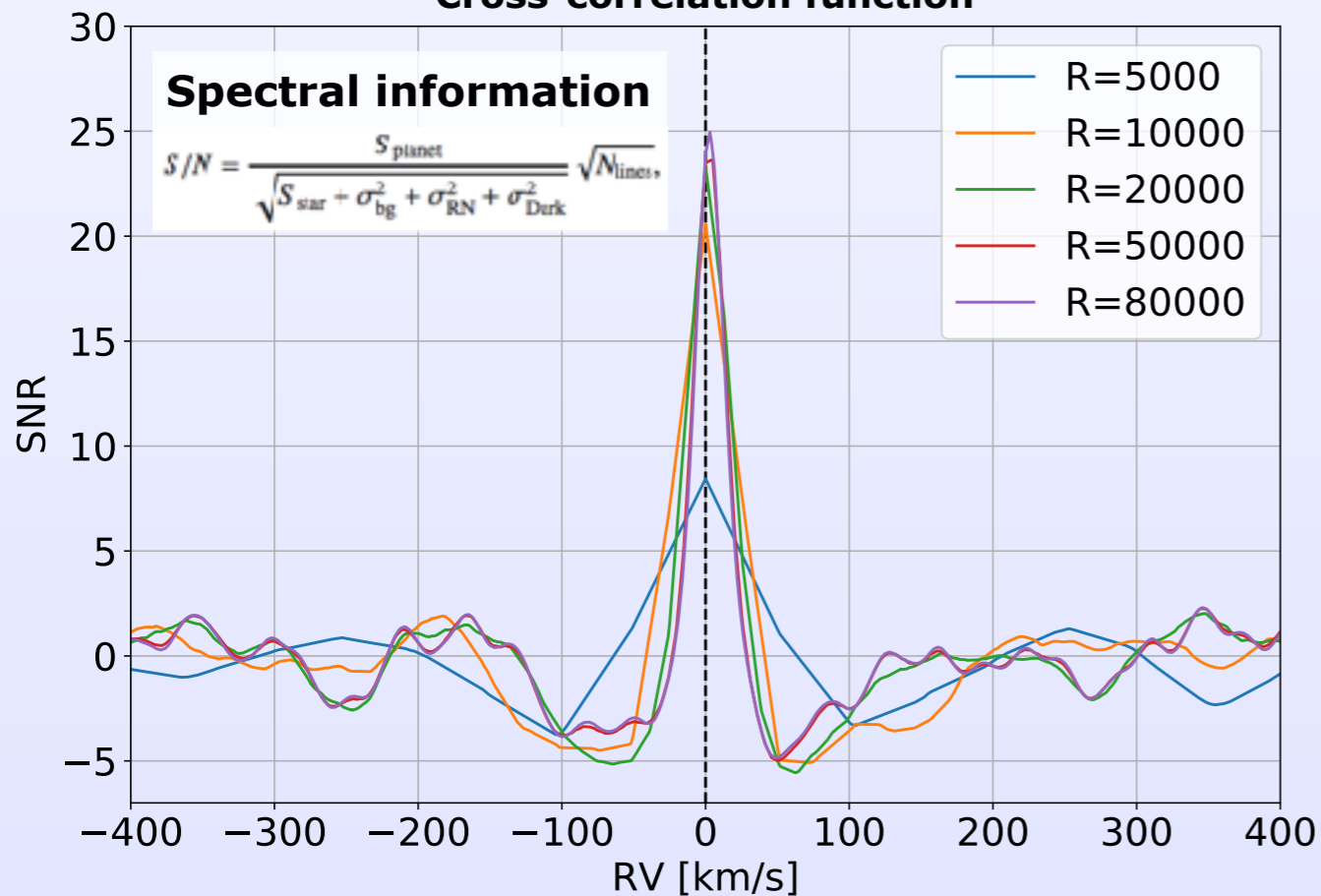

Detection boost at high-spectral resolution

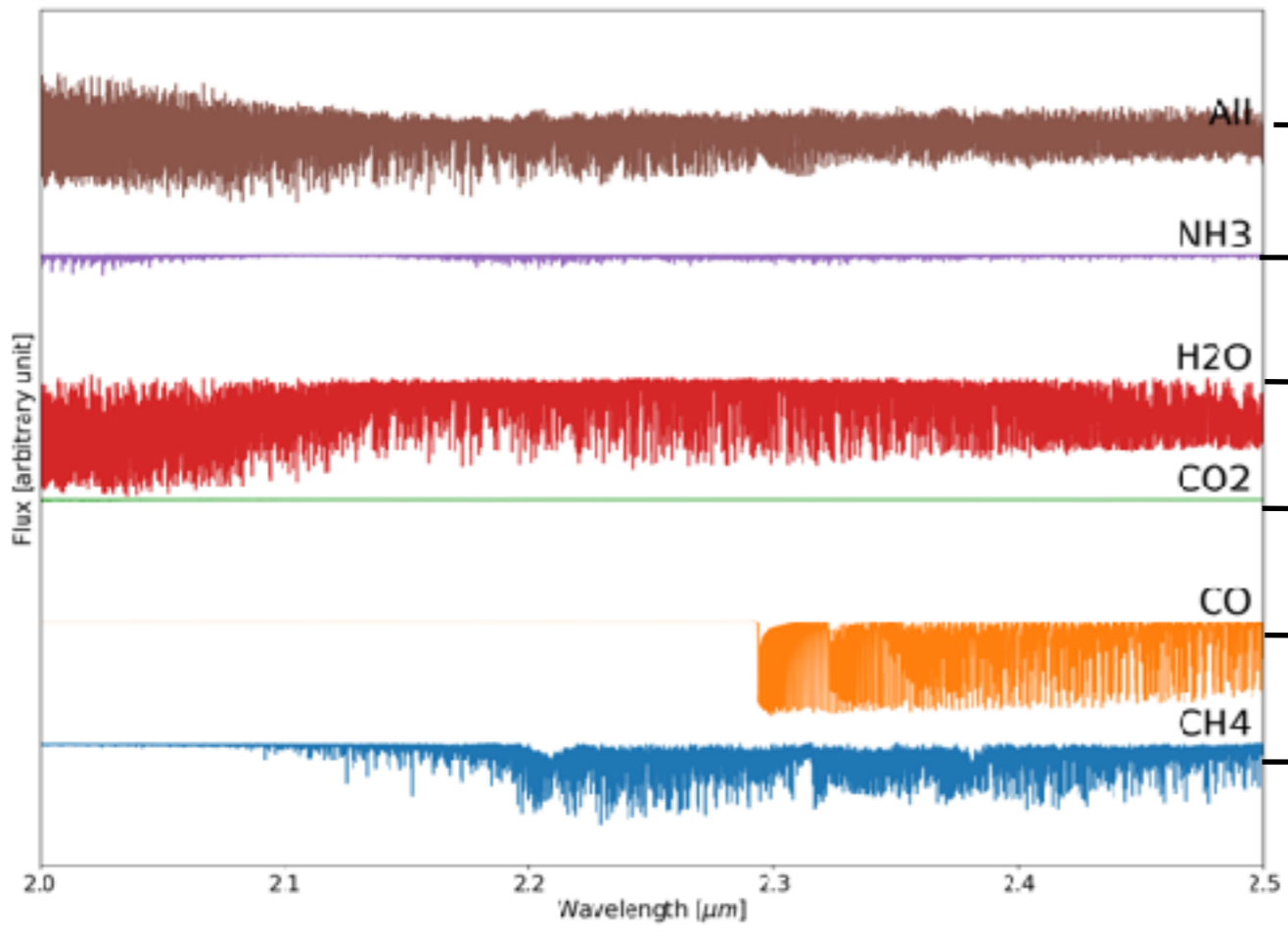

Standard CCF approach

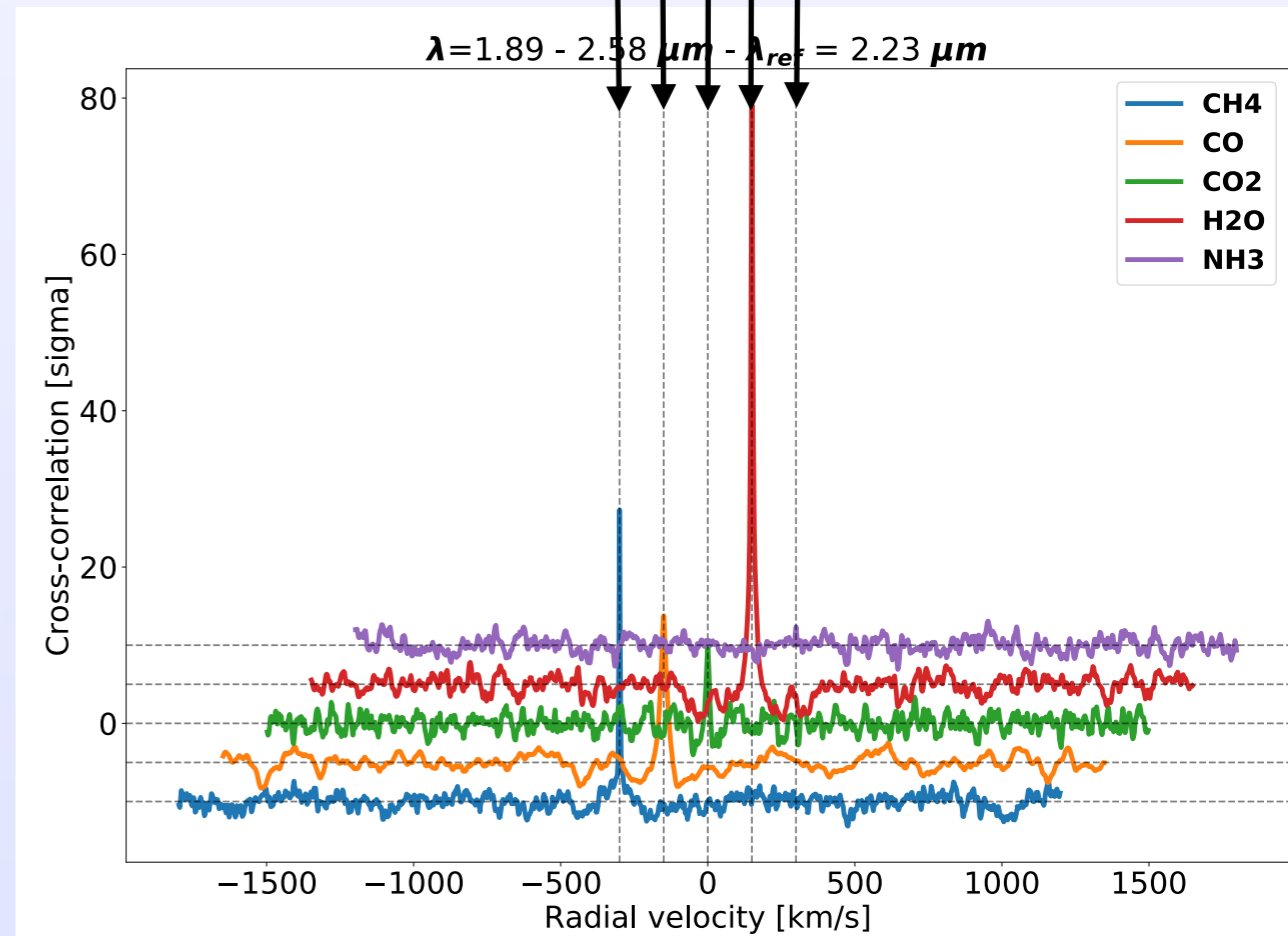

ATMO models
Tremblin et al. (2015)
Philipps et al. (2020)

Detection boost at high-spectral resolution

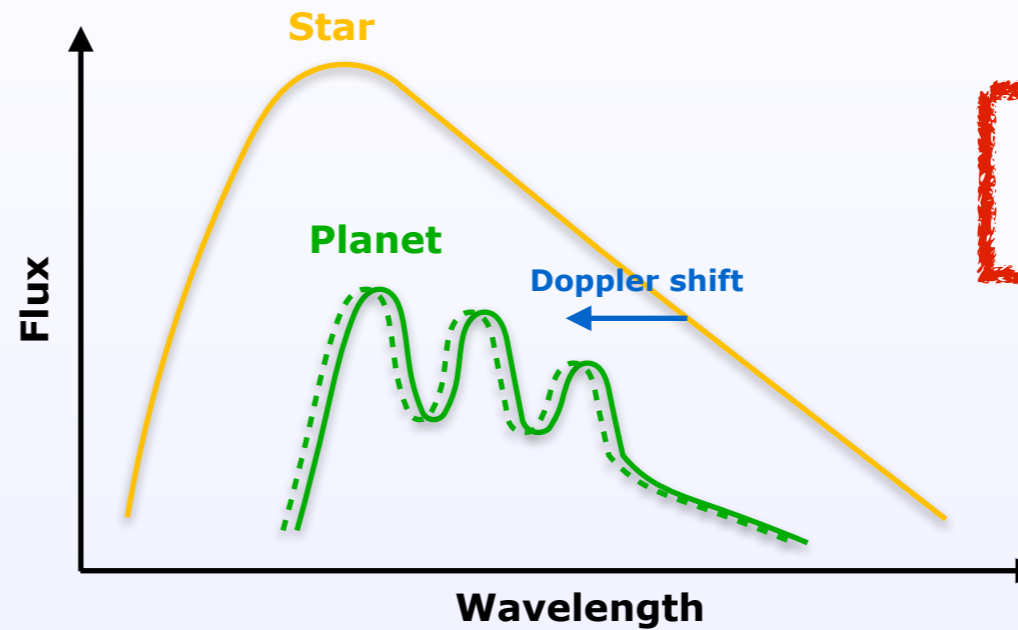
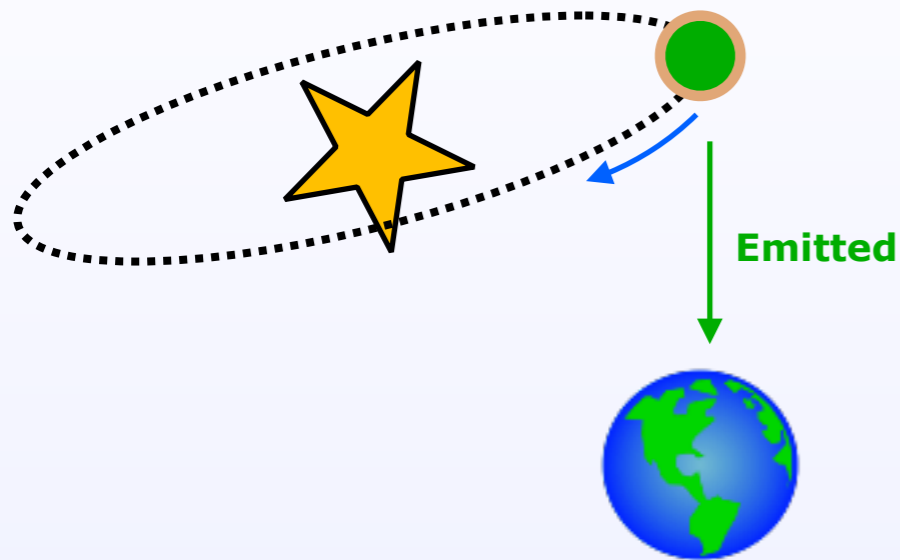

Requires
 $R \gg 10\,000$

Cross-correlation function

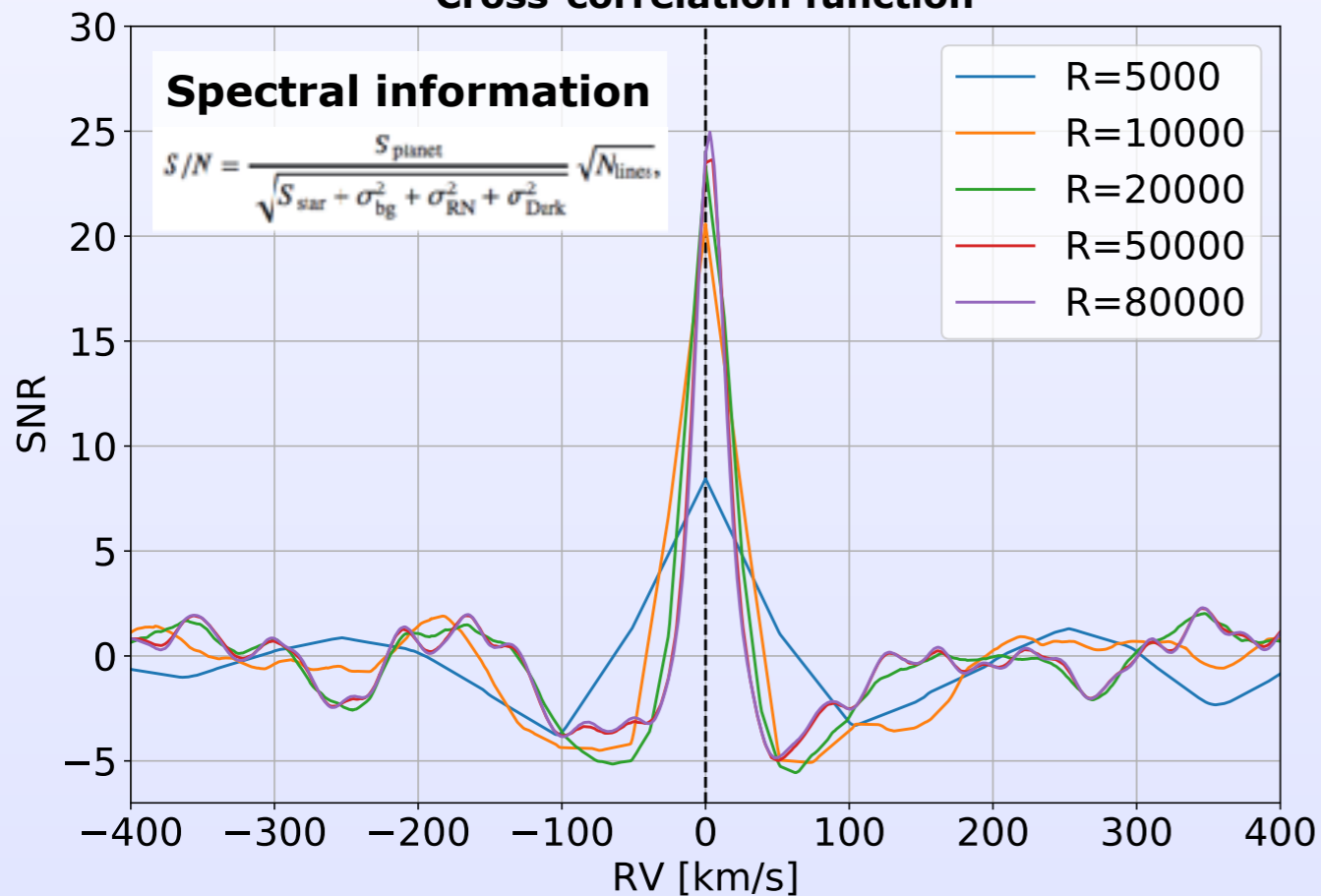

Cross-correlation function

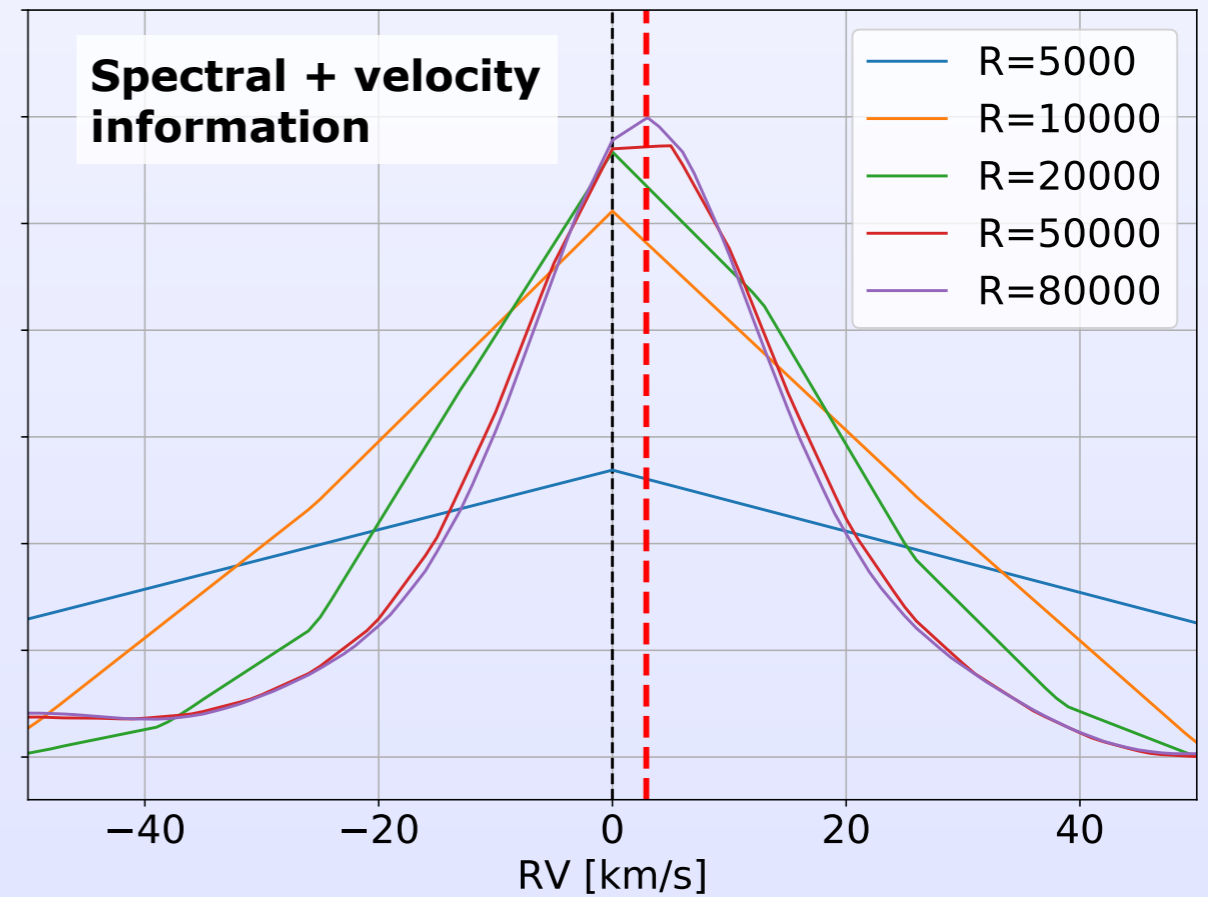

Characterisation at high-spectral resolution

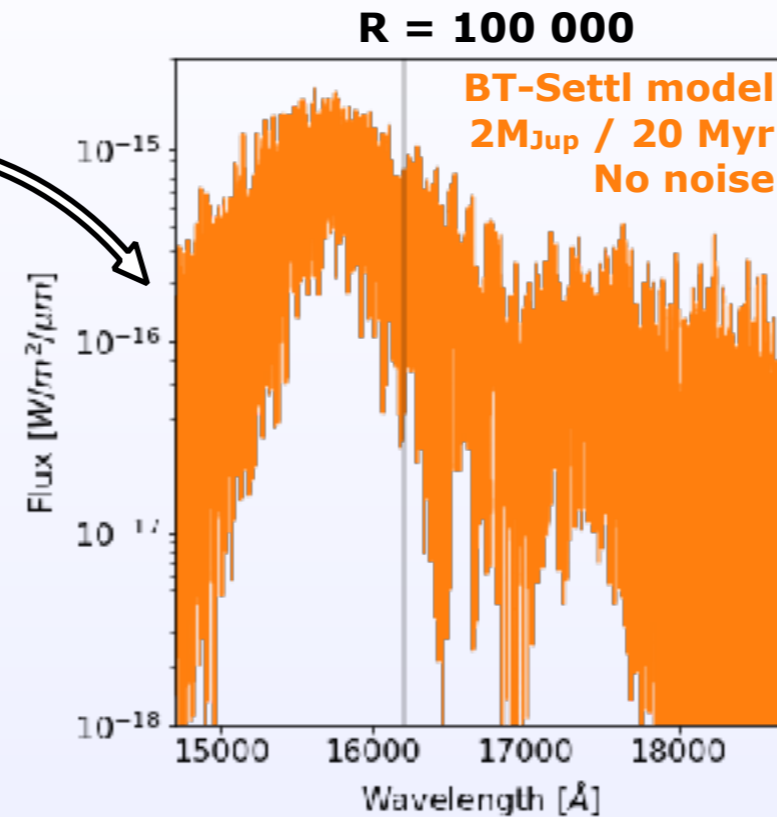
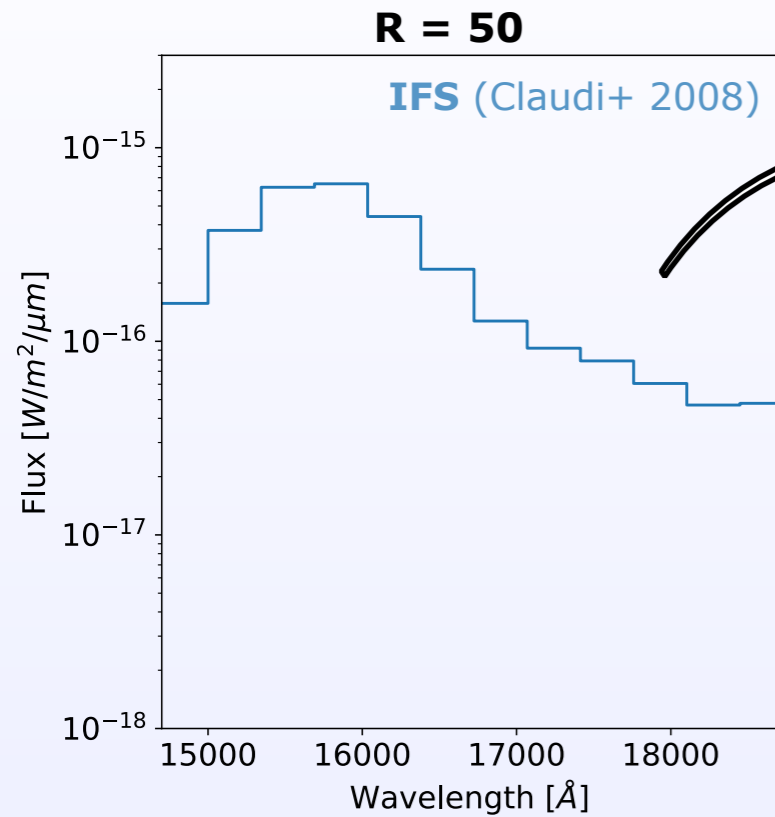

**Requires
 $R \gg 10\,000$**

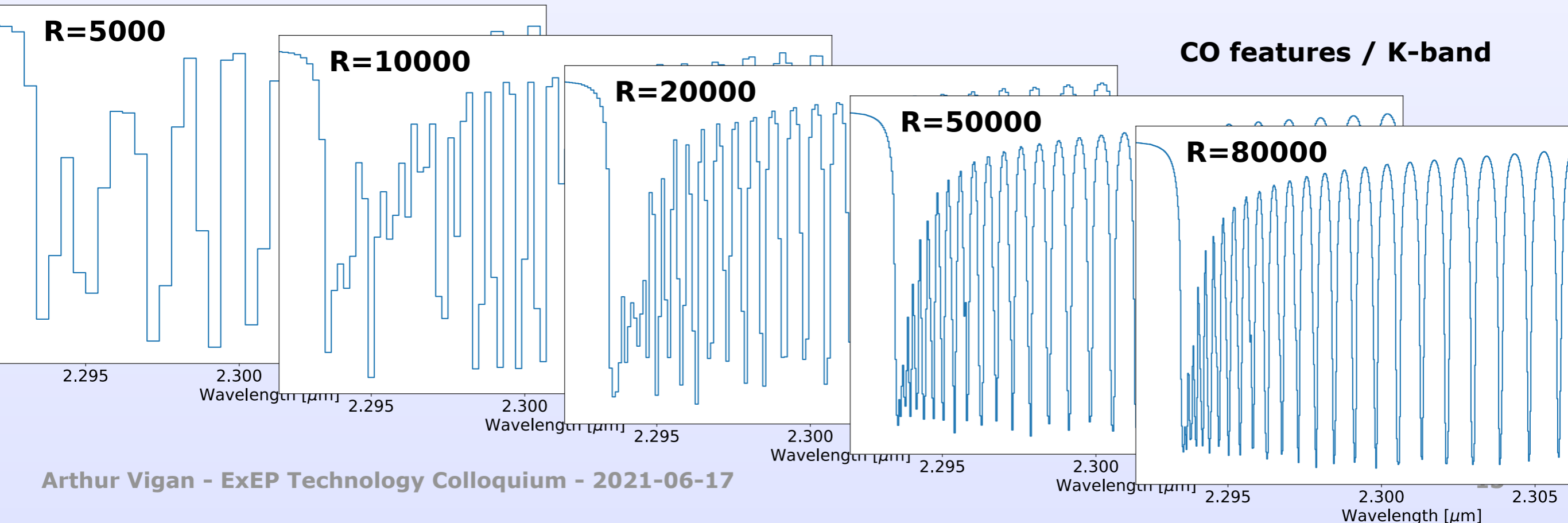

Exoplanet science at high resolution

Molecules detection

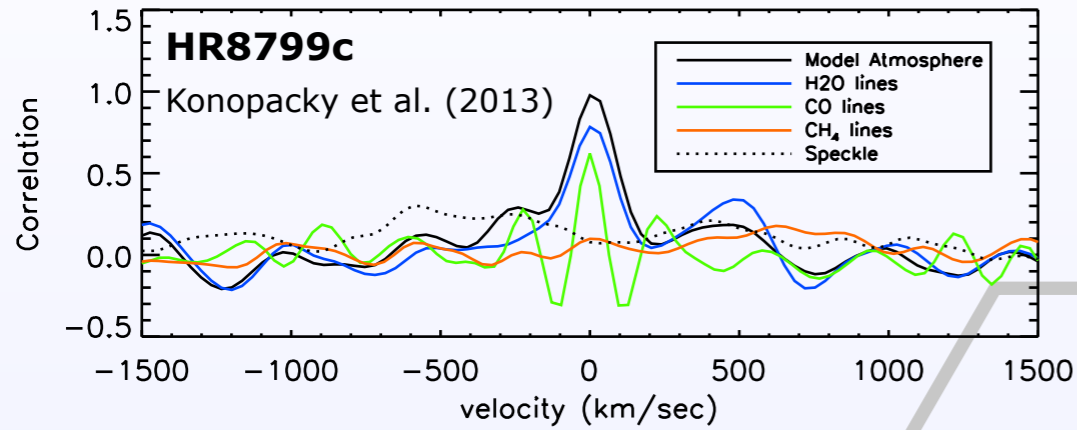

Isotopologues detection

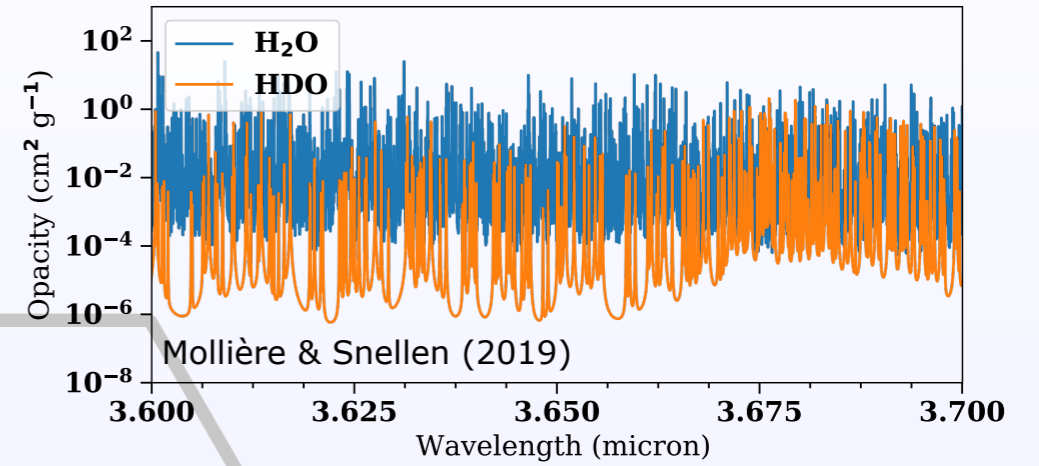

Formation,
migration & evolution

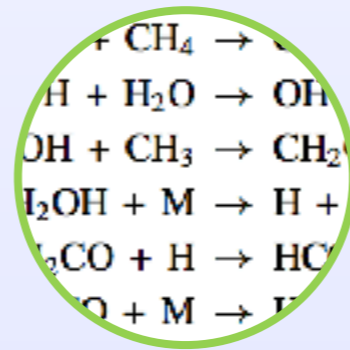

Accretion lines

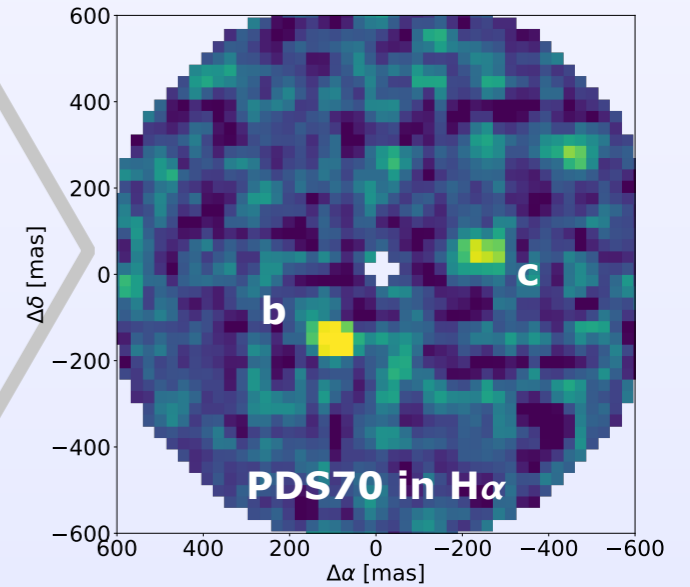

Abundances determination

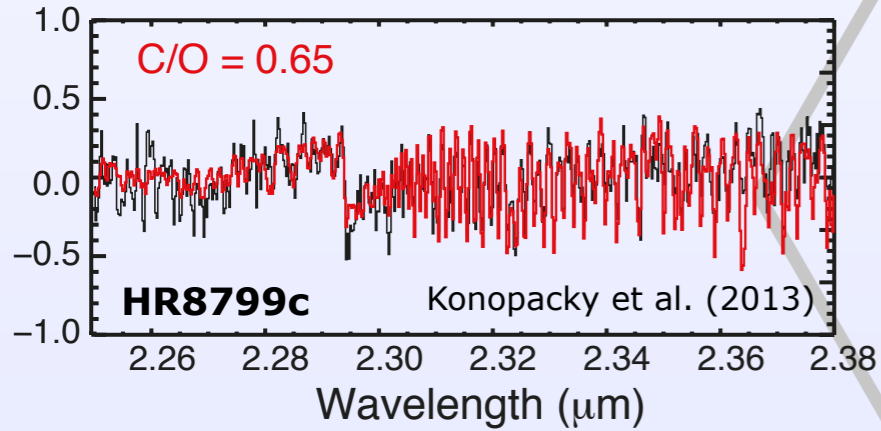

Orbital and rotational velocity

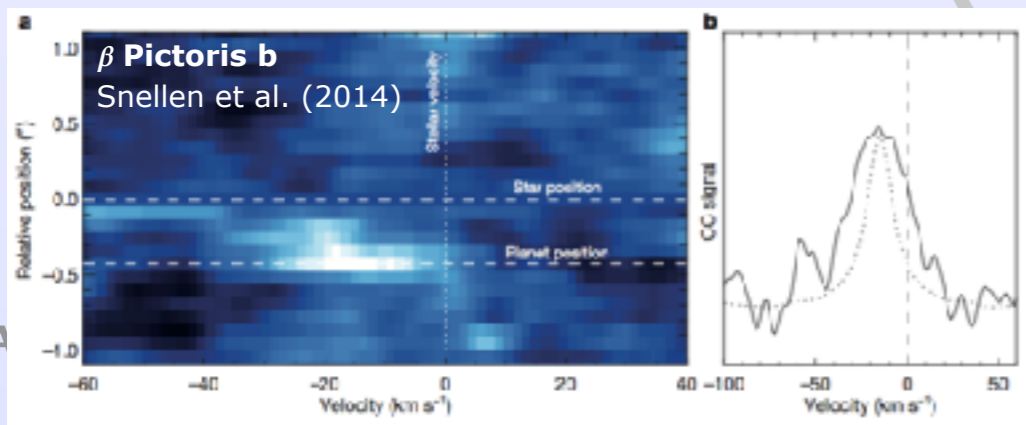

Variability & Doppler imaging

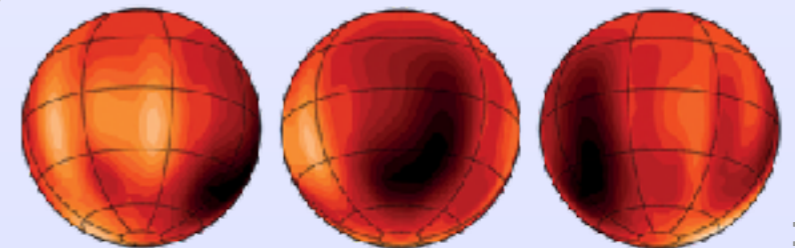

Luhman 16B (Crossfield et al. 2014)

Young exoplanets characterisation in near-IR

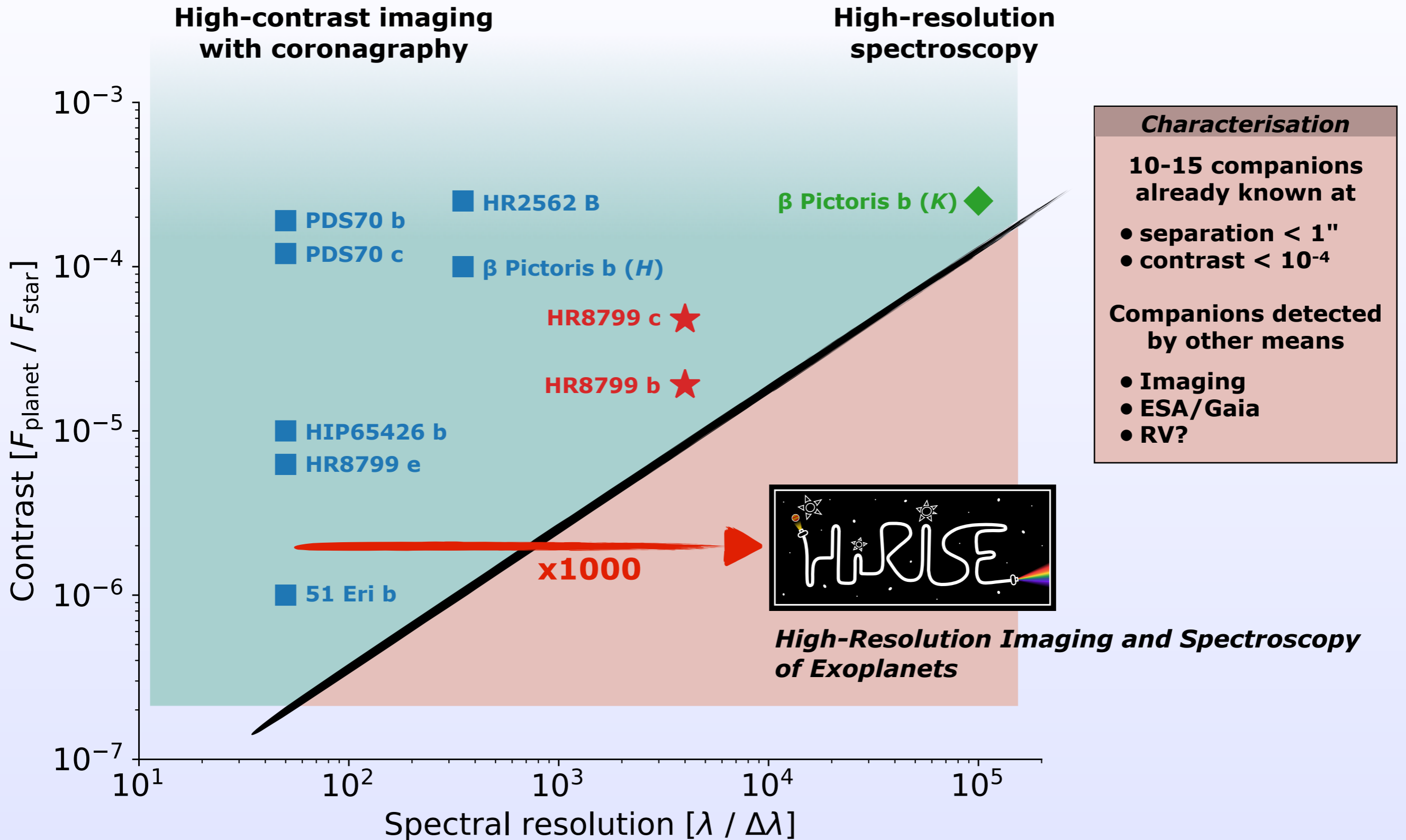

A unique window of opportunity

VLT/UT3

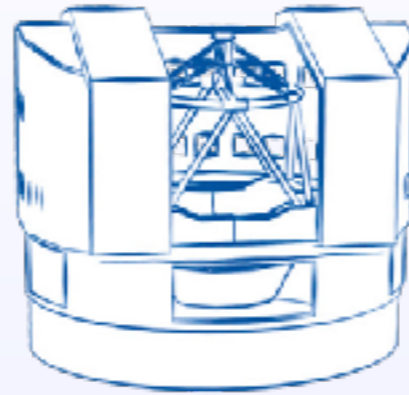

High-contrast exoplanet imager



High-resolution spectrograph



Y J H K

50 - 350

Extreme adaptive optics

Coronagraphy

Spectral coverage

Spectral resolution



Y J H K L M

50 000 - 100 000

Fiber coupling

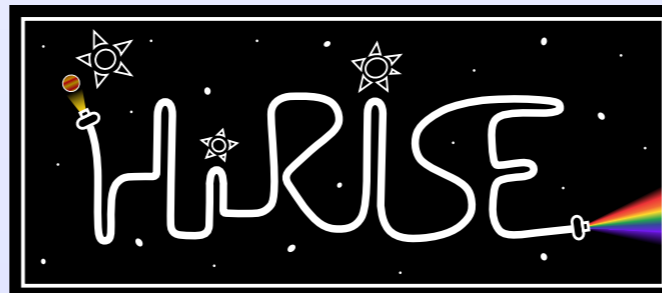

Implementation



Fiber extraction module (FEM)



Fiber injection module (FIM)

Fiber bundle

Fiber injection module in SPHERE

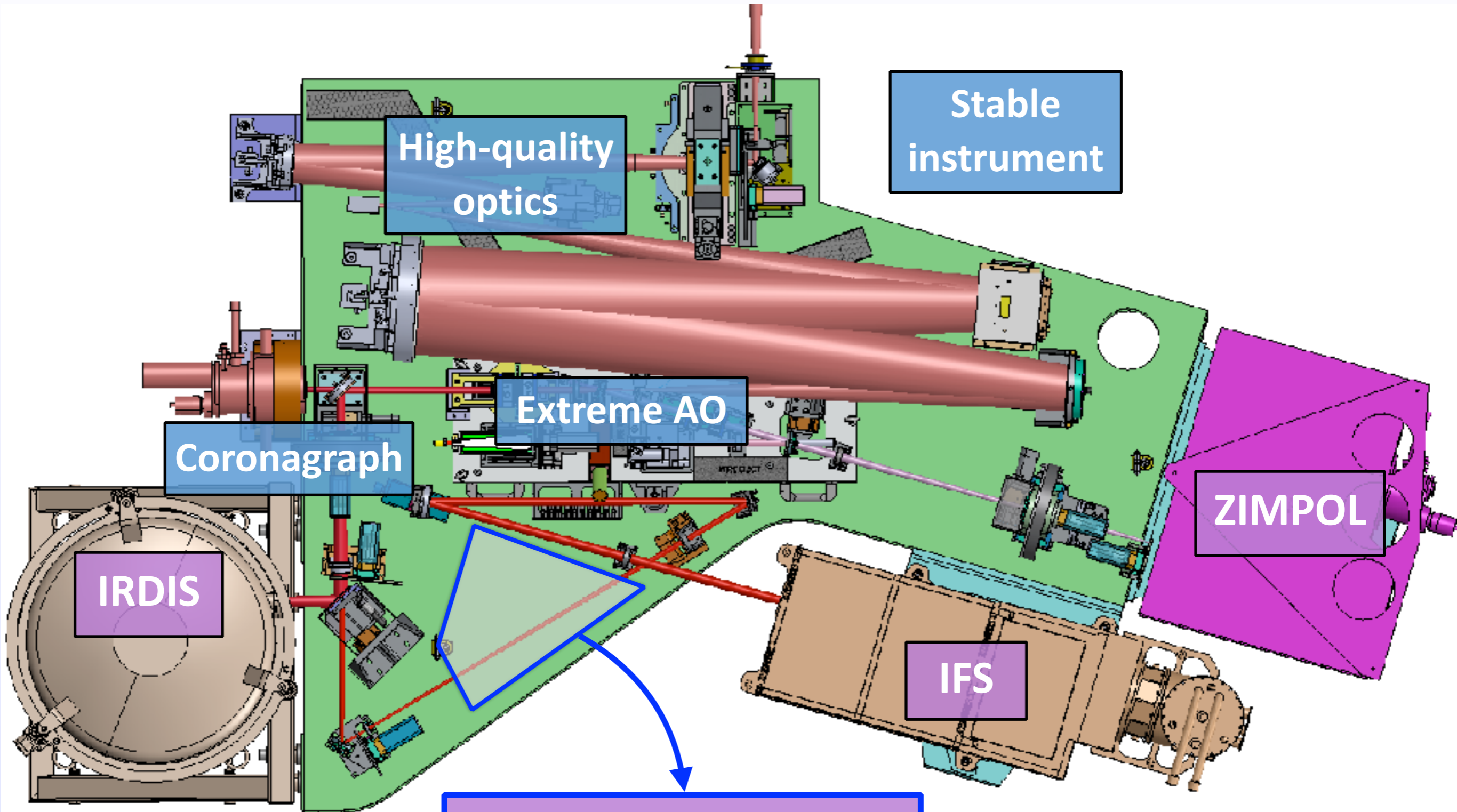

High-quality optics

Stable instrument

Extreme AO

Coronagraph

ZIMPOL

IRDIS

IFS

HiRISE
Fiber Injection Module

FIM conceptual design

- Removable pick-off mirror
- Tip-tilt in closed loop for positioning
- Long wavelengths to single-mode fibre
- At least 2 fibres
 - science
 - reference

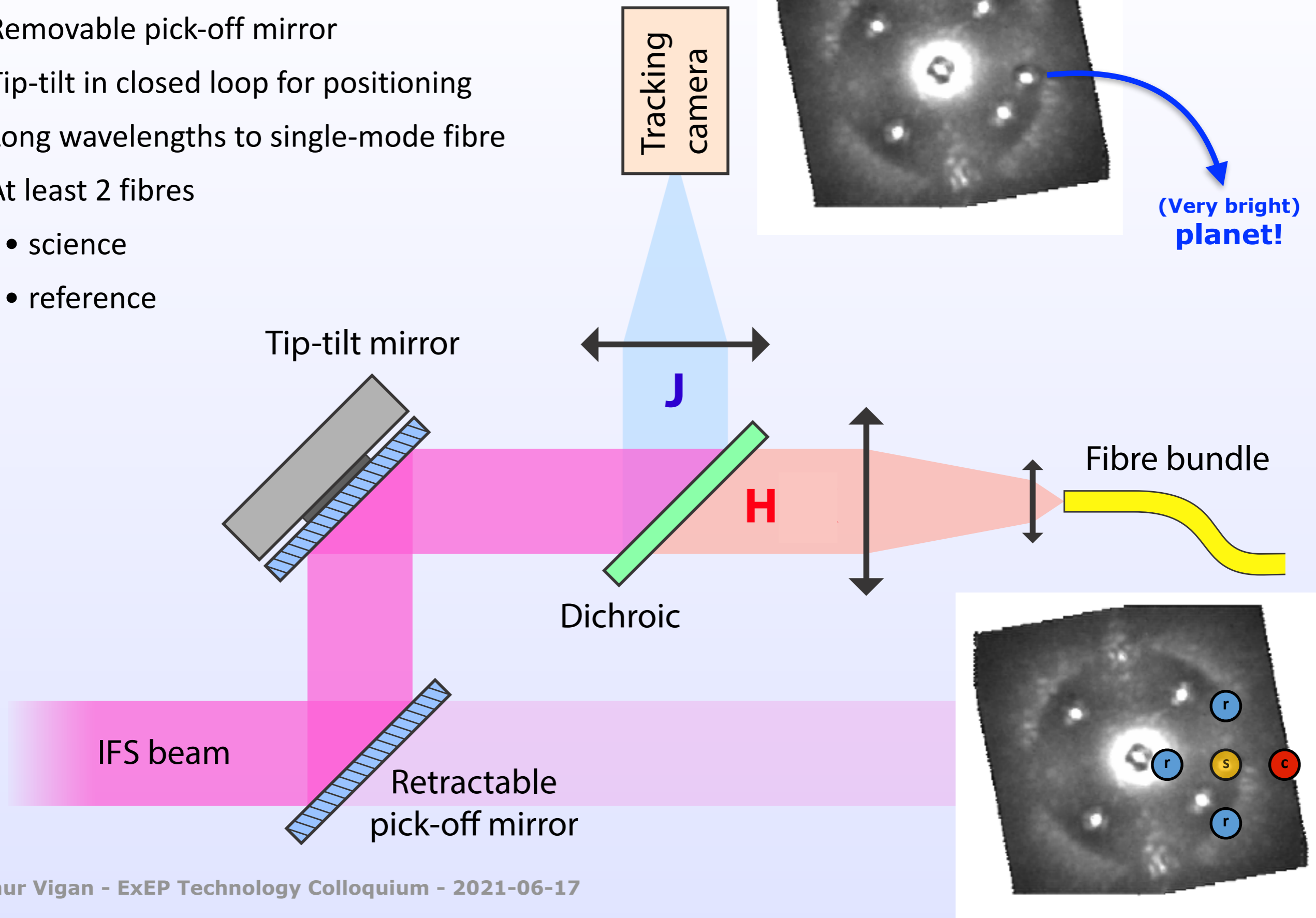

Optical design

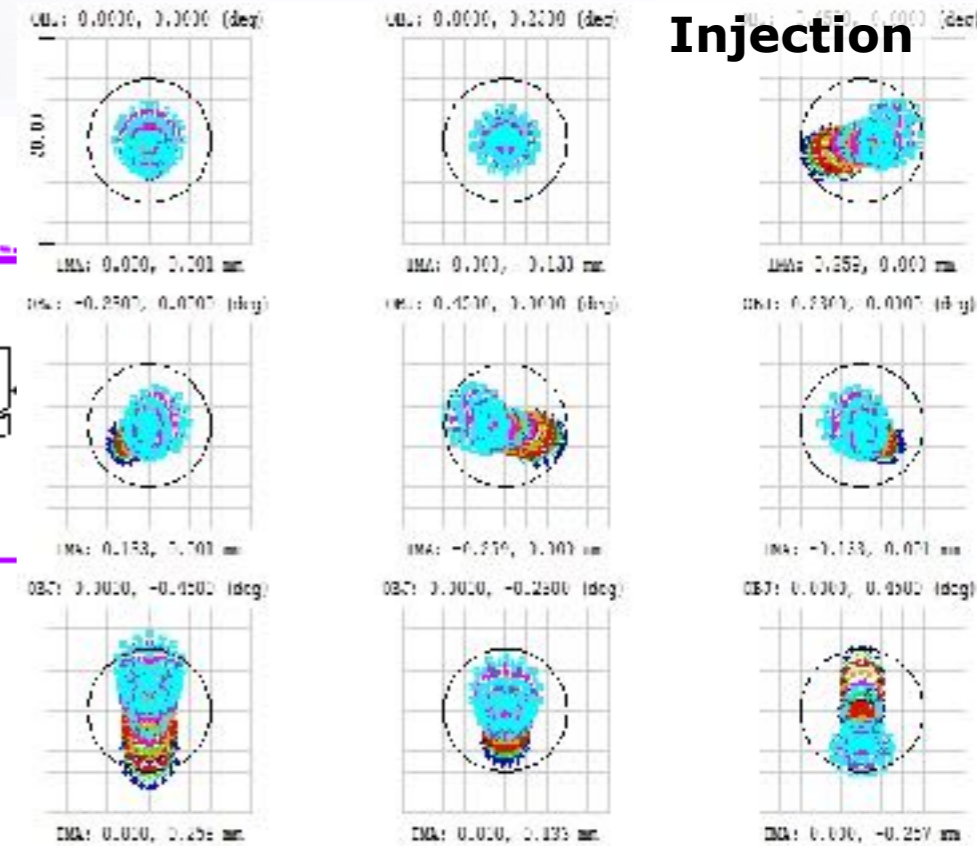
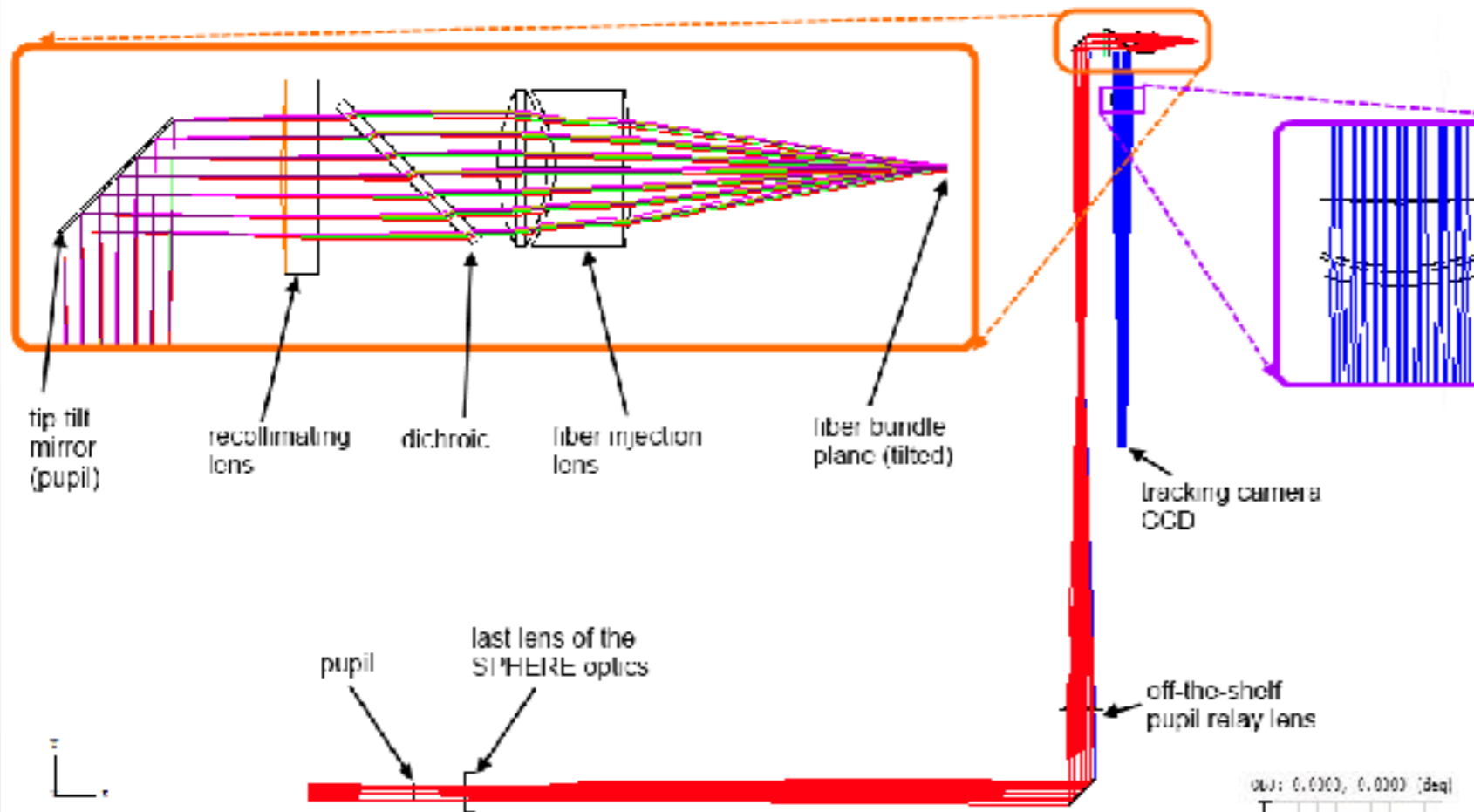

~30 nm rms on axis

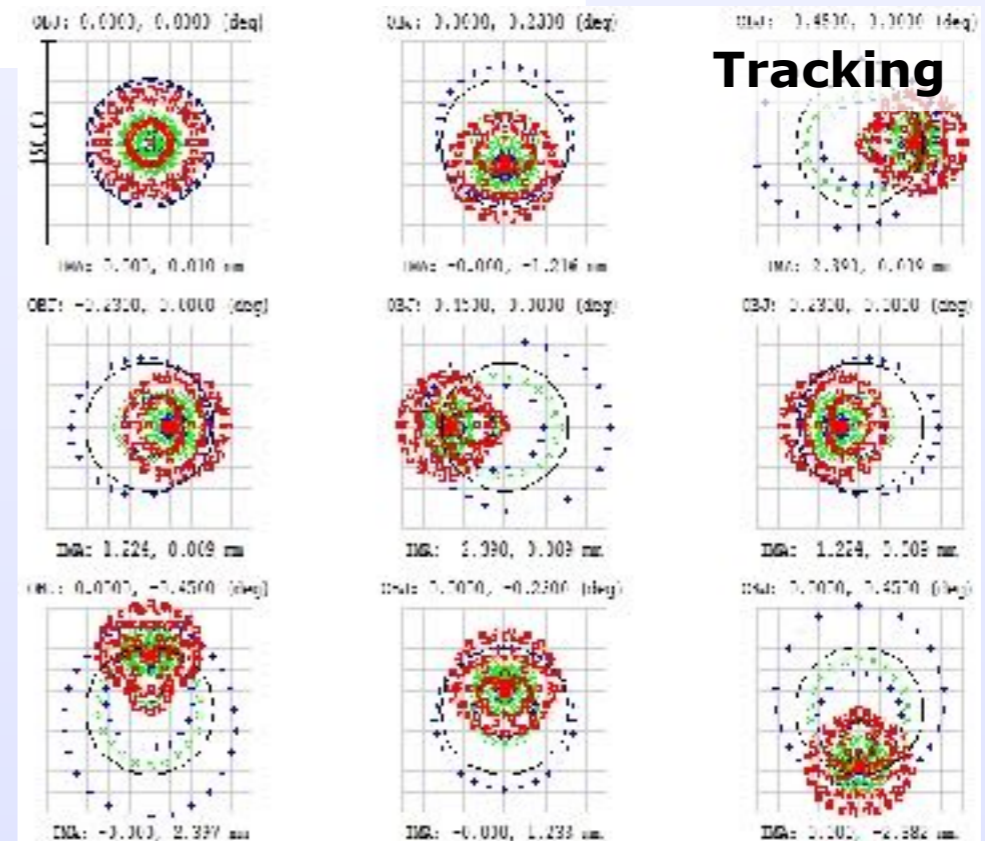
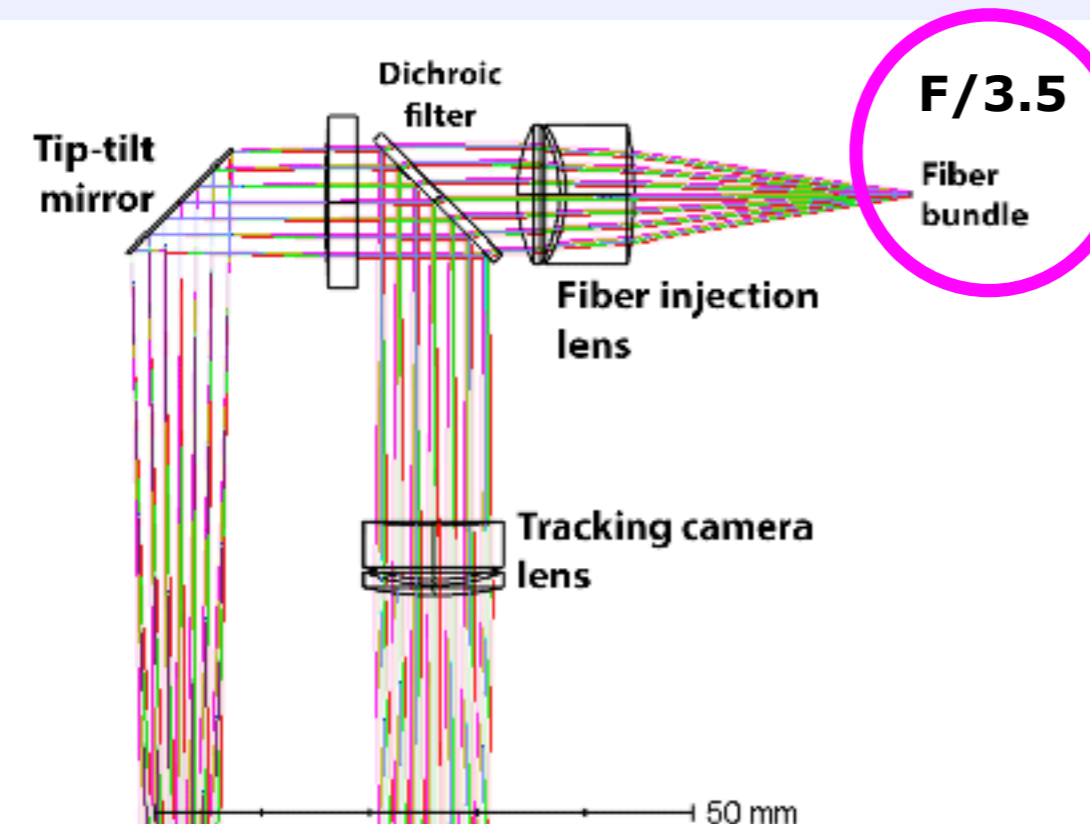

~60 nm rms on axis

HiRISE injection efficiency

How much stellar/planetary light can you inject into an SMF?

- Single-mode fiber:
 - EM_{00} mode is quasi-Gaussian

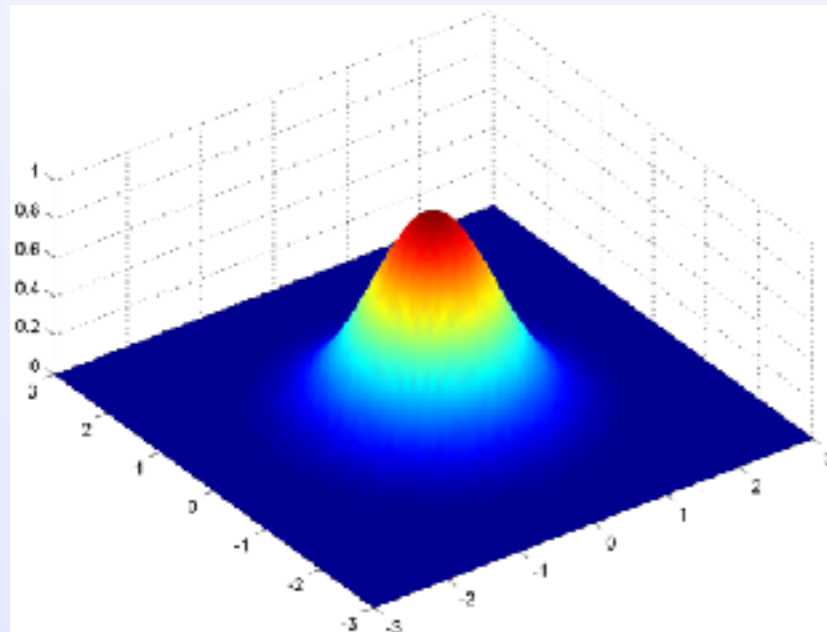

- Telescope PSF:
 - Obstructed pupil + spiders
 - Complicated pattern

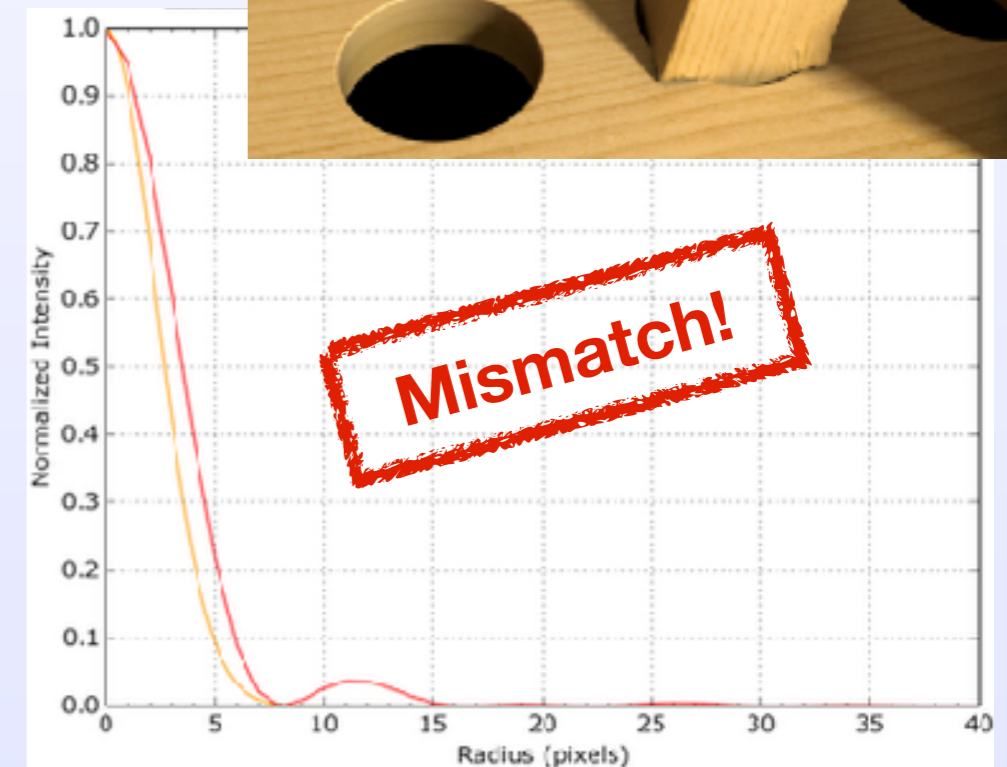
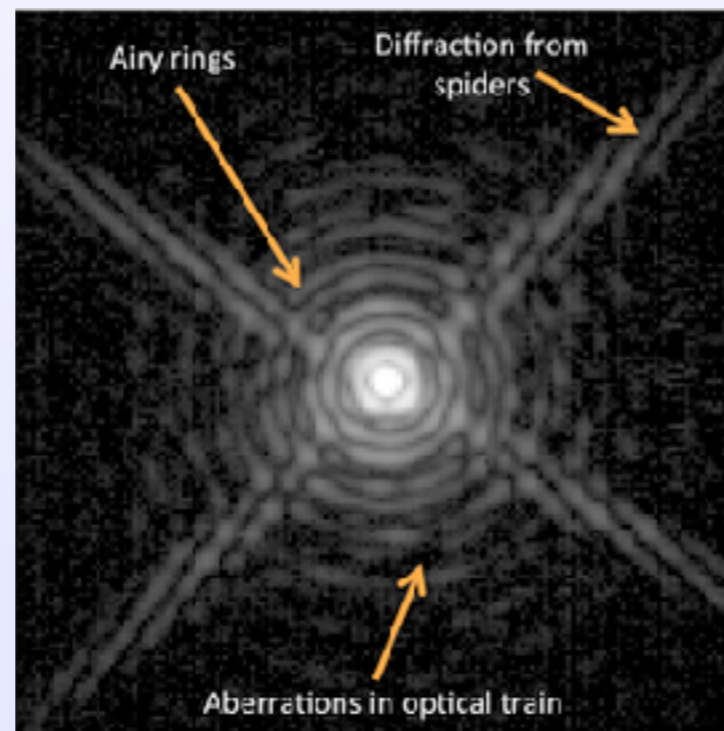

Jovanovic et al. (2017)

HiRISE injection efficiency

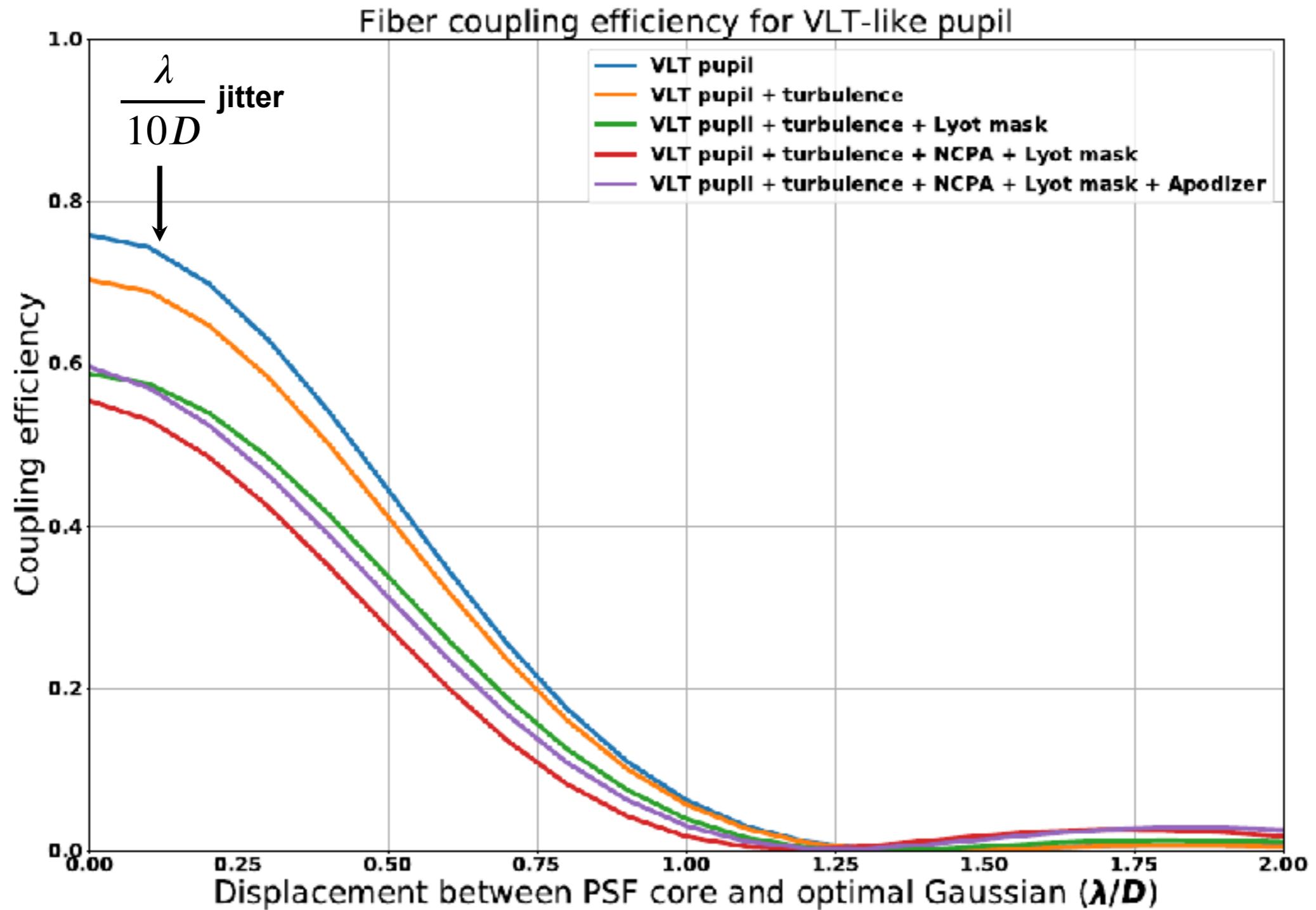

Fiber injection module in CRUED



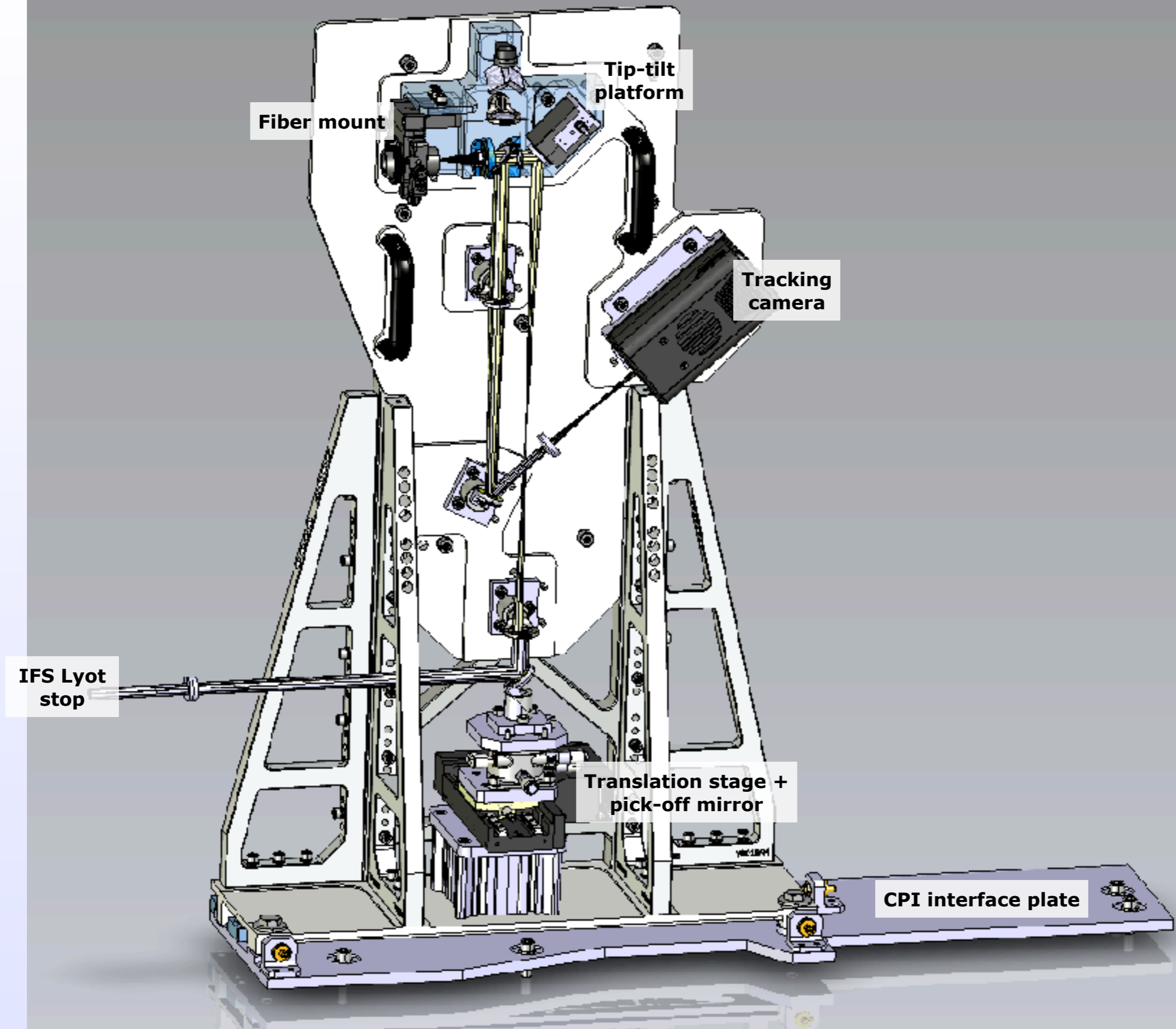

Fiber mount

Tip-tilt platform

Tracking camera

IFS Lyot stop

Translation stage + pick-off mirror

CPI interface plate

Fiber injection module in

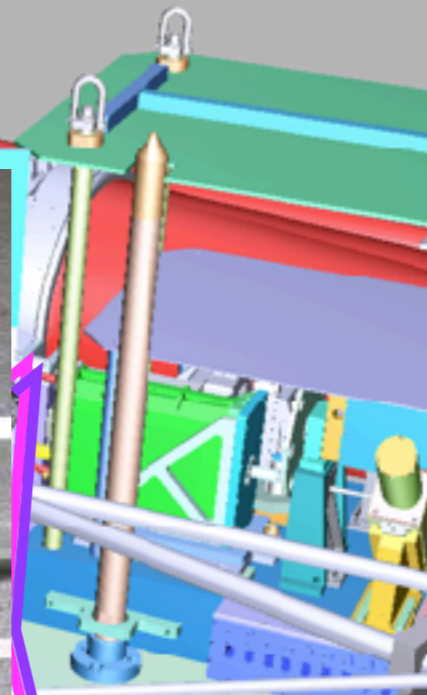
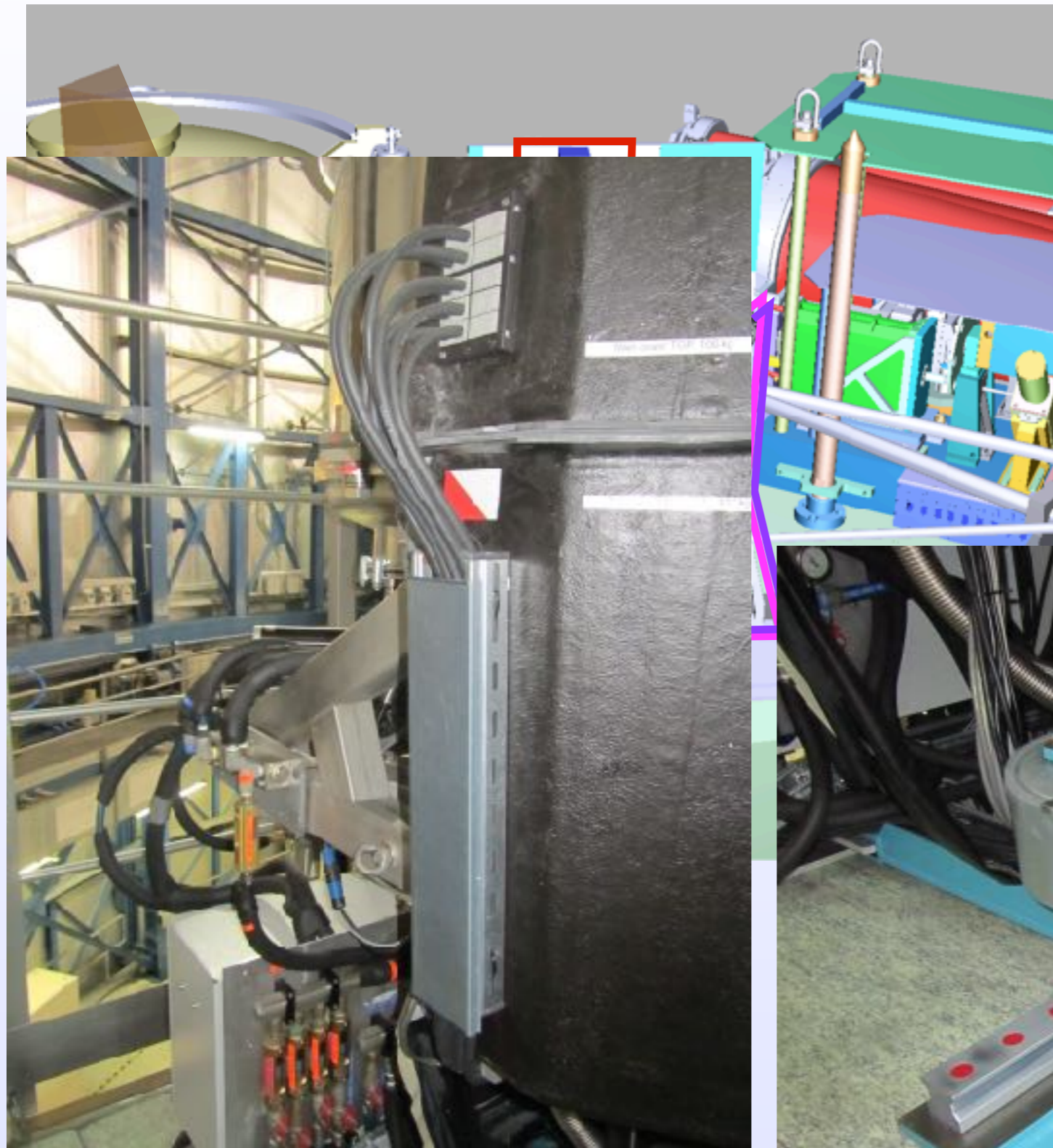

Fiber bundle

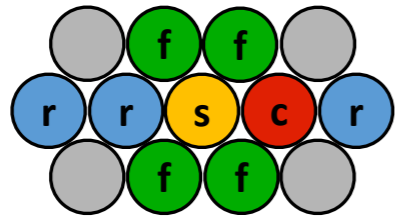

2d assembly, AR coating

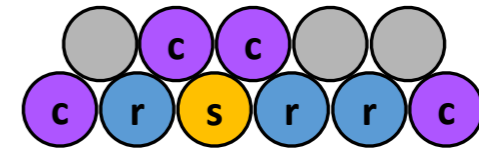

2d assembly, AR coating

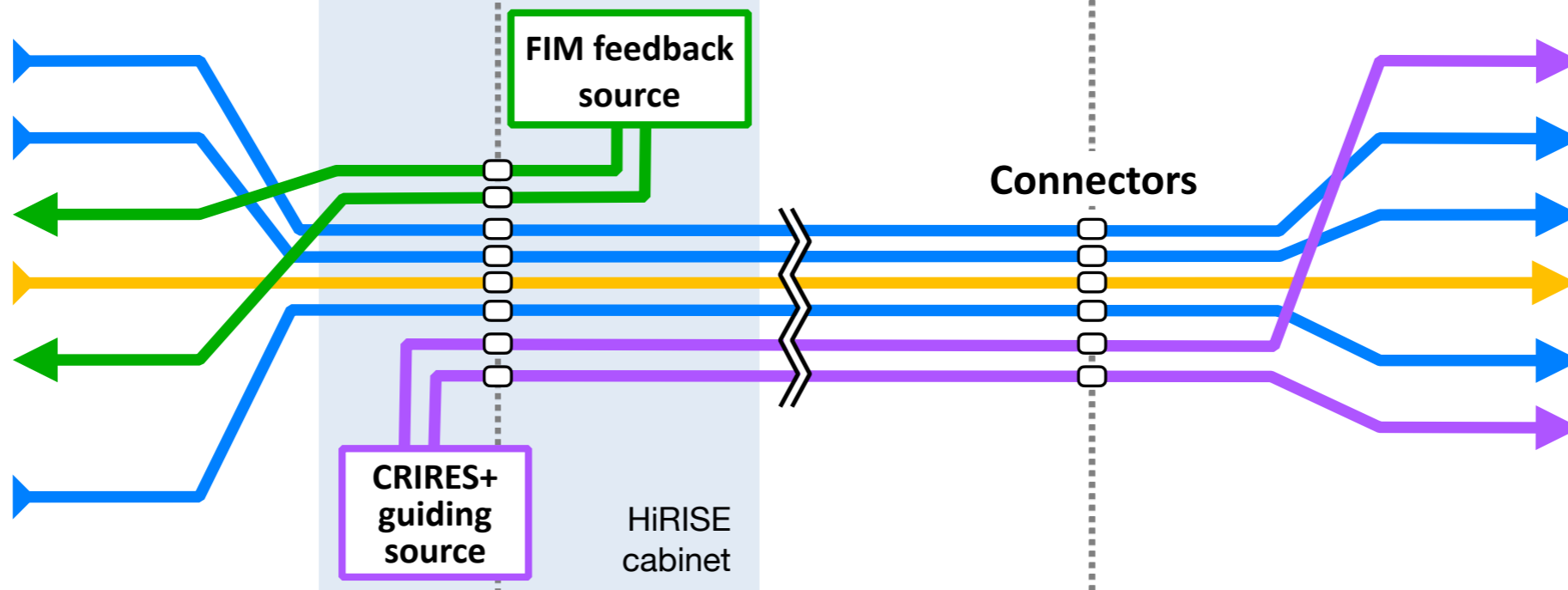

SPHERE section
~5 m

Long section
~50 m

CRIRES+ section
~5 m

Science fibers (Nufern 1310M-HP)

- **s** Science fiber, planet, 1.4-1.8 μm
- **r** Reference fiber, star, 1.4-1.8 μm

Calibration fibers (Nufern 1310M-HP)

- **f** SPHERE feedback fiber, max 1.4 μm
- **c** CRIRES+ calib fibers, 0.8-1.6 μm

Fiber bundle with connectors

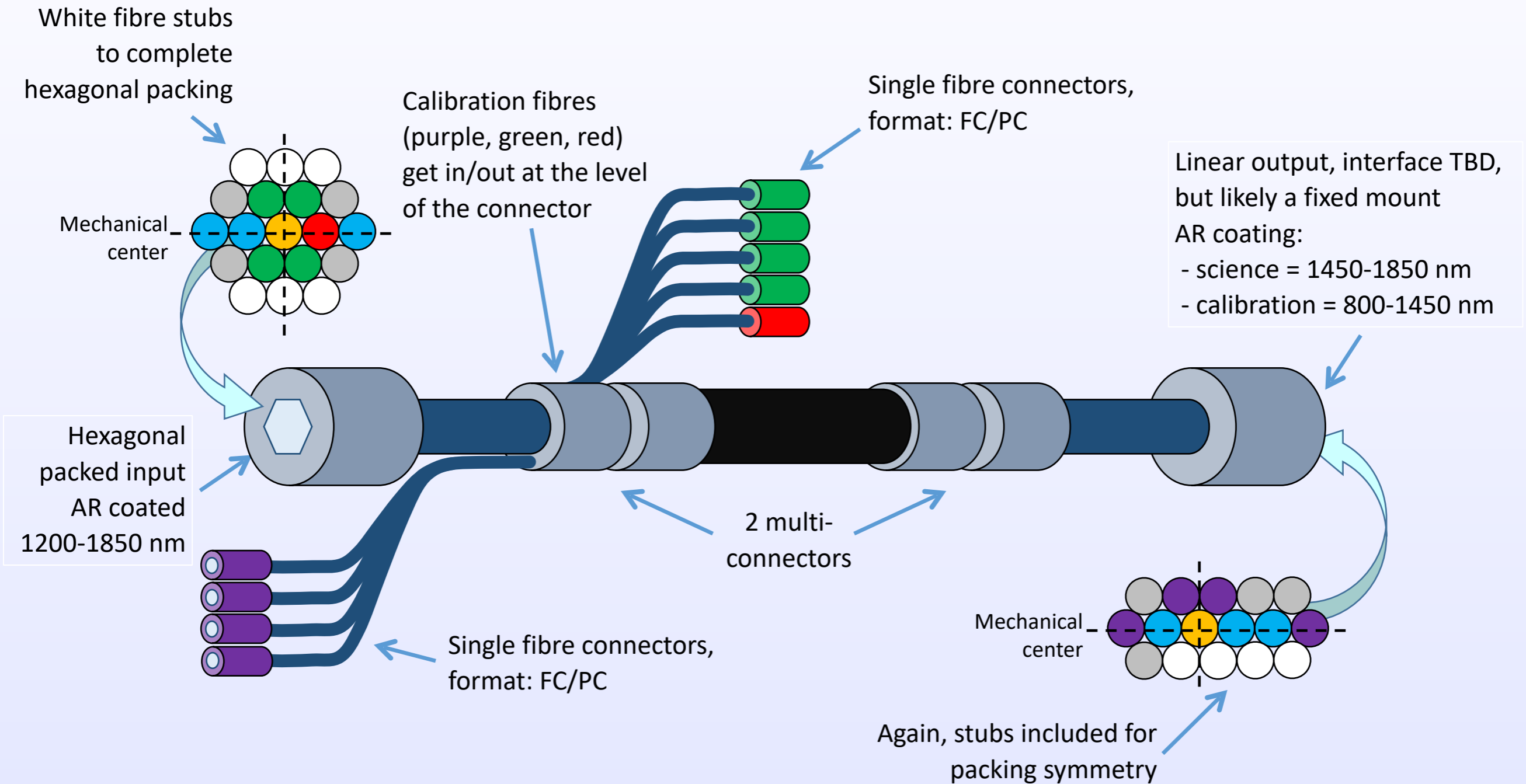

Fiber bundle without connectors

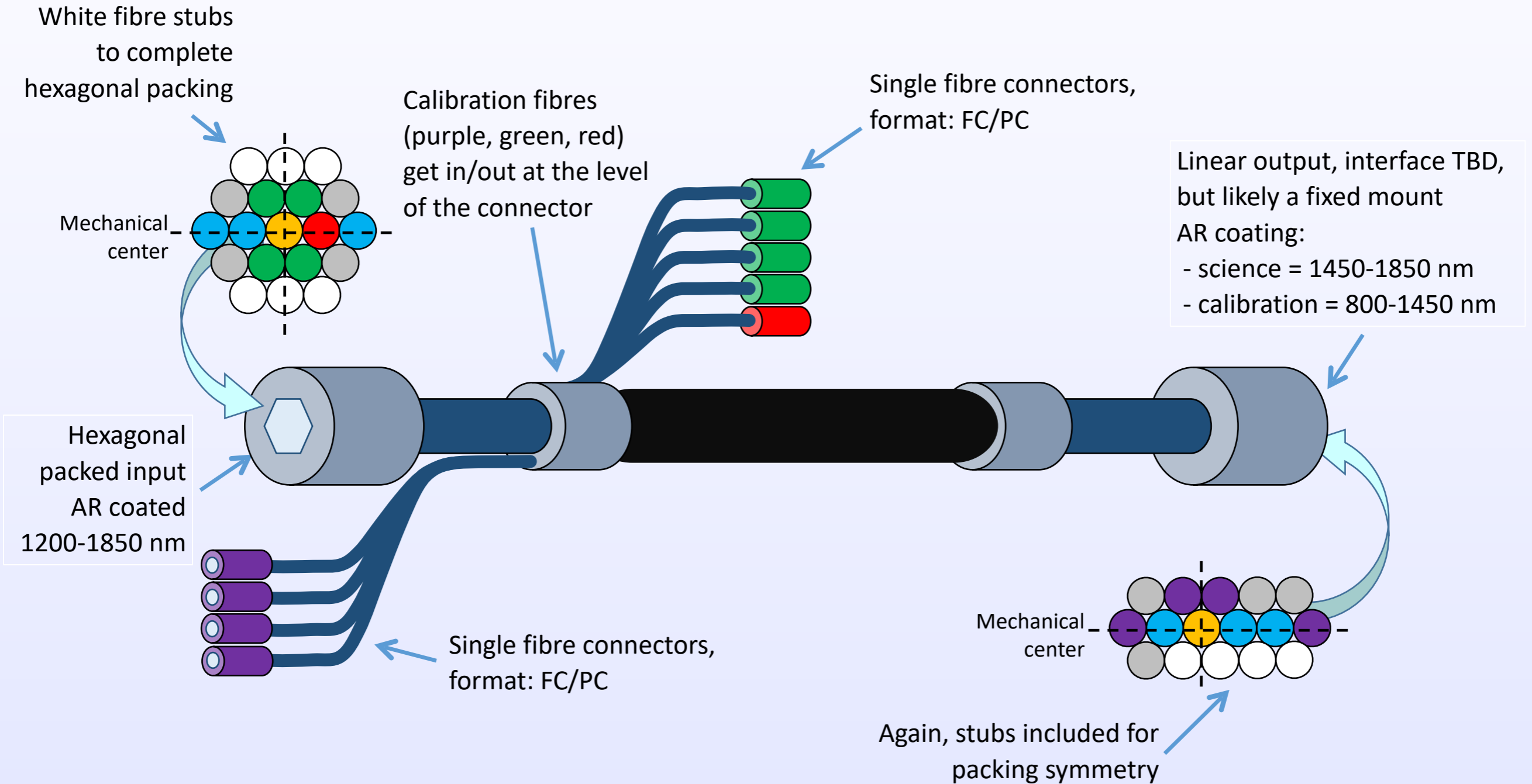

Low-loss connectors

- Throughput is a key driver of the performance
- Problem: single-mode fibres have very small cores! Typically 4-8 μm

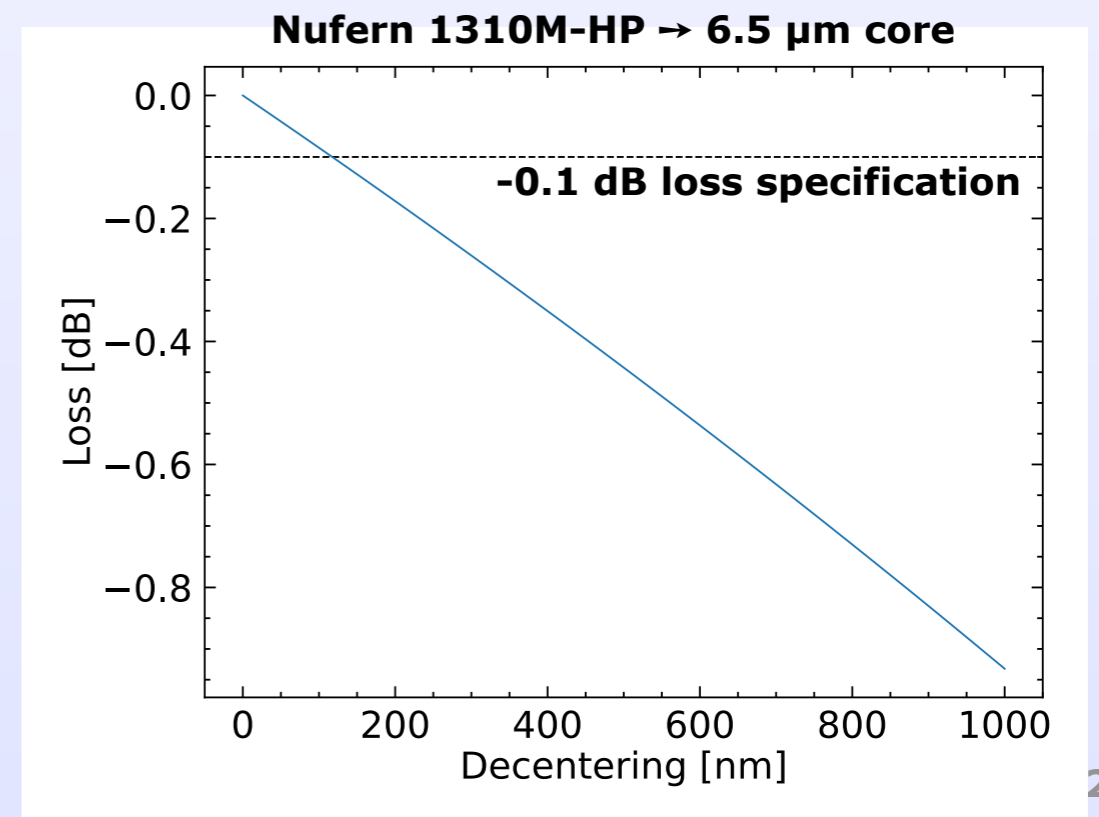
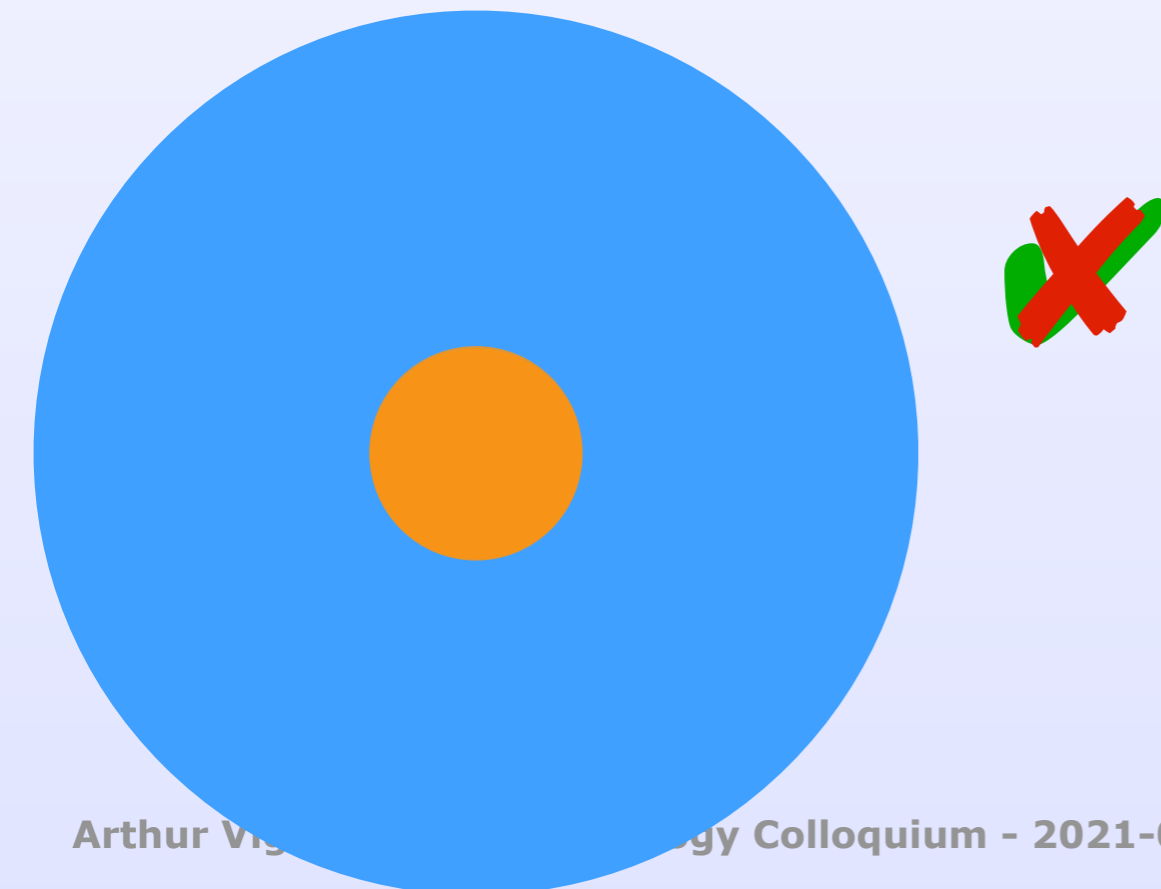

Low-loss connectors

- Rugged connectors with repeatable connection exist...



- ... but they need properly aligned fibres in the first place
- Only solution on the market: Diamond SA, Active Core Alignment

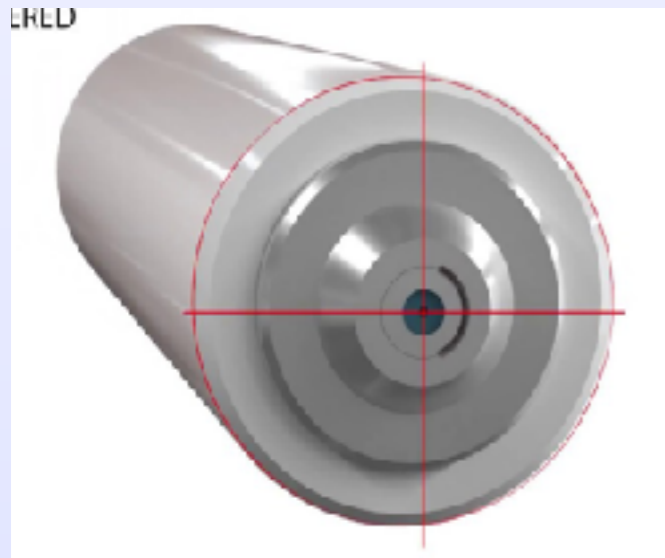

<https://www.diamond-fo.com/technologies/technology/active-core-alignment-aca/>

Fiber bundle around UT3

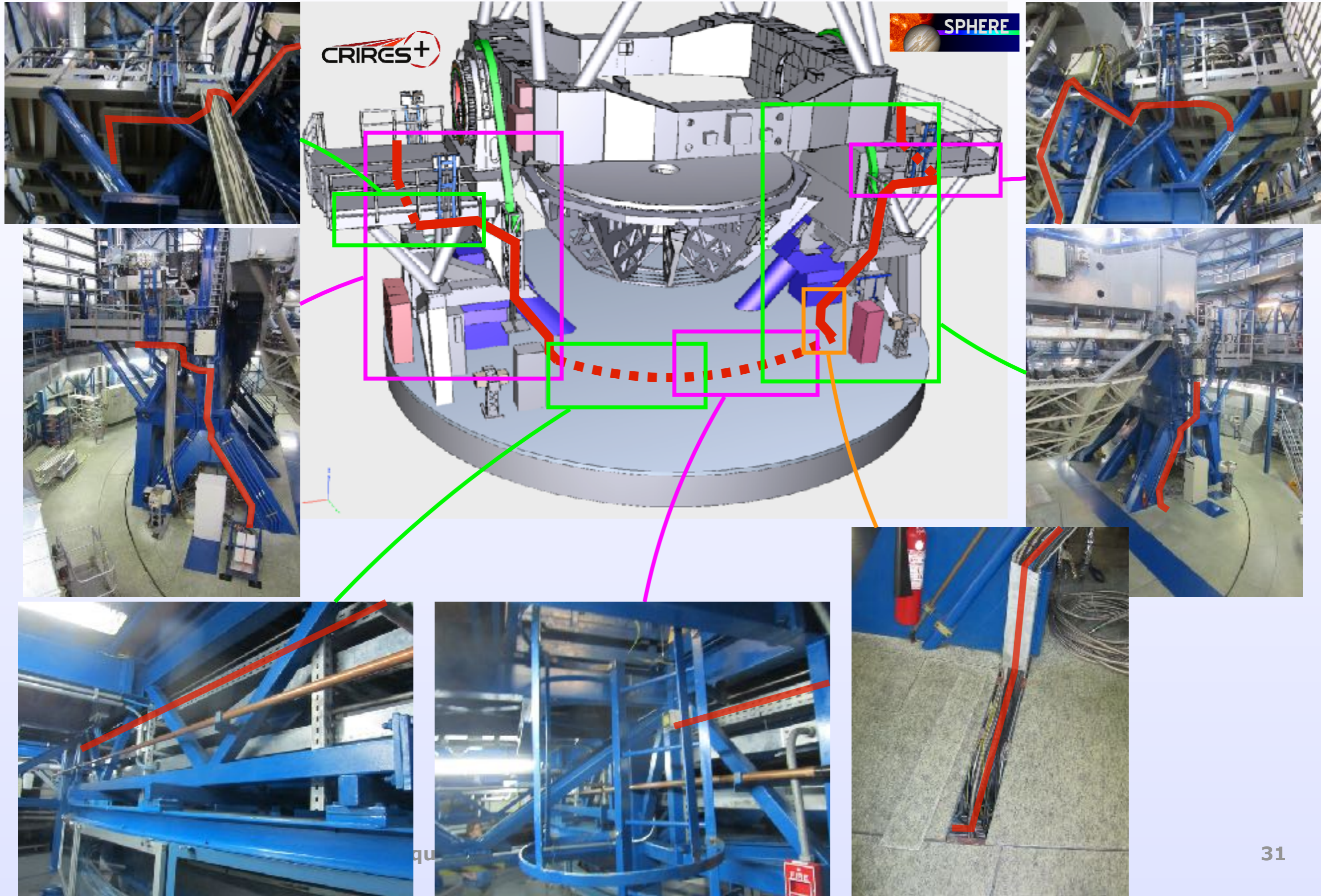

Fiber extraction module in CRIRES+

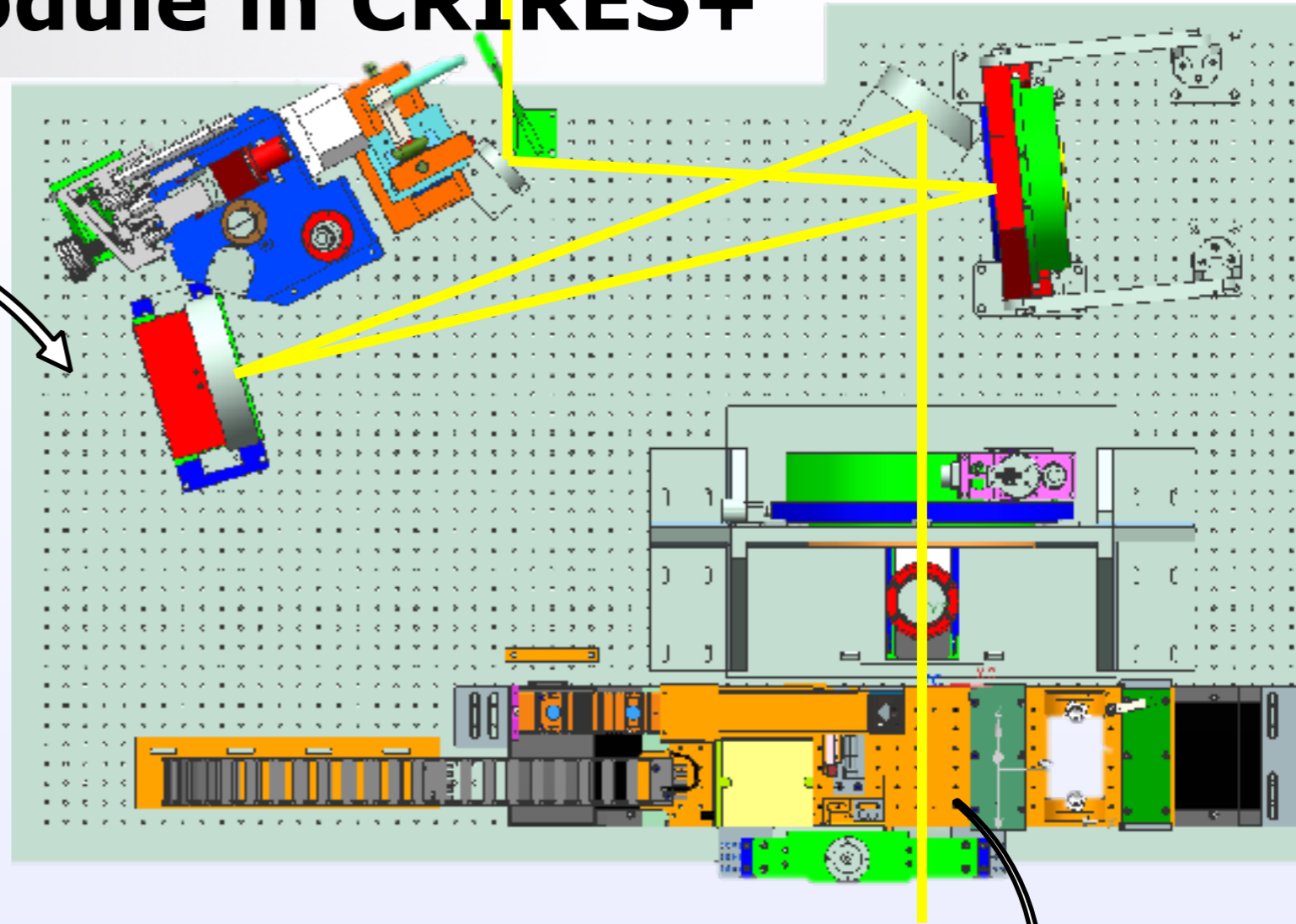
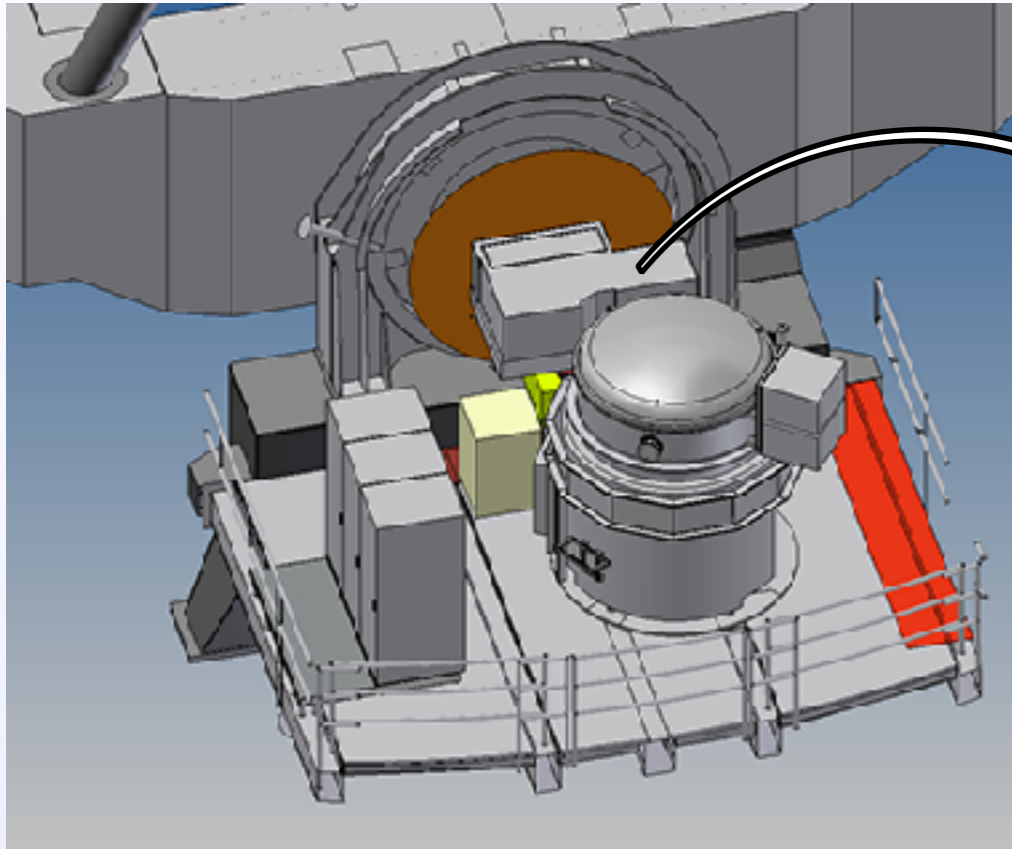

FEM optics

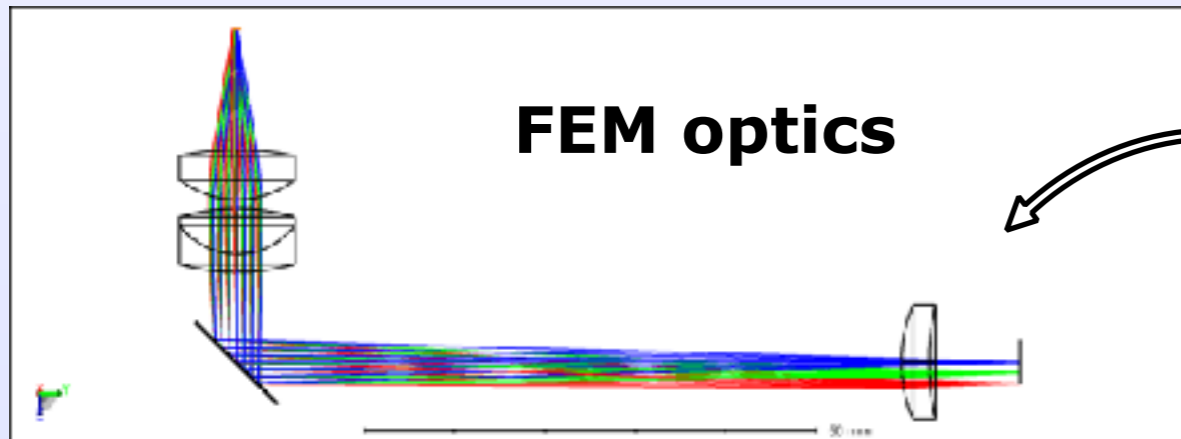

CRIRES+ carriage selector unit

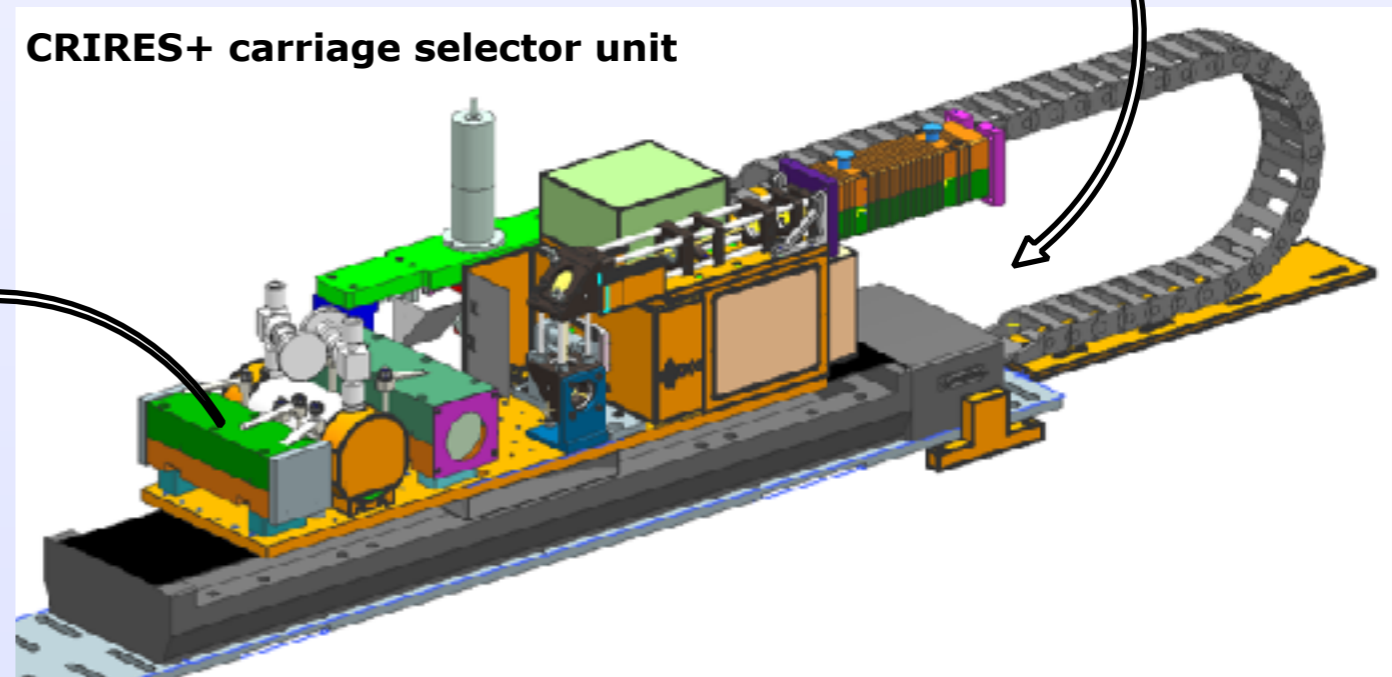

Fiber extraction module in CRIRES+

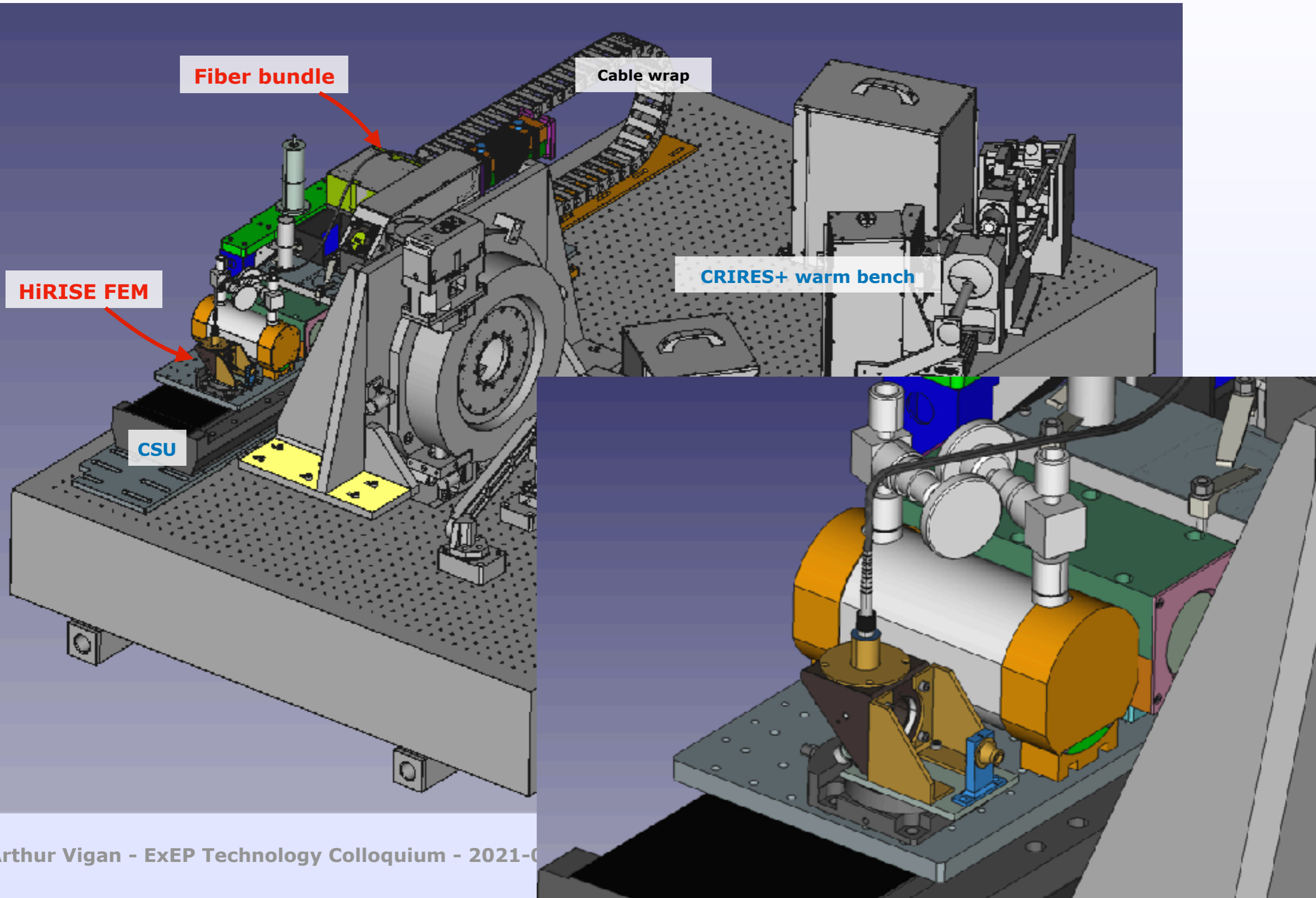

CRIRES+: improving CRIRES

- NIR infrared echelle spectrograph
- New cross-dispersion gratings stage
- New Hawaii-2RG detectors
- Improved polarimetric unit

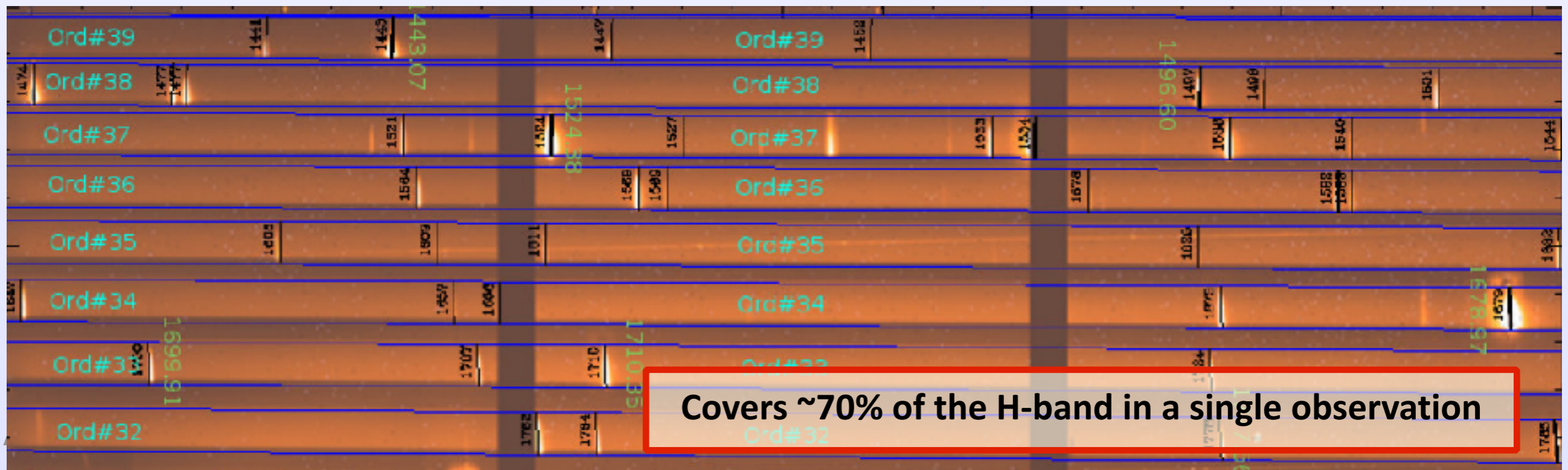
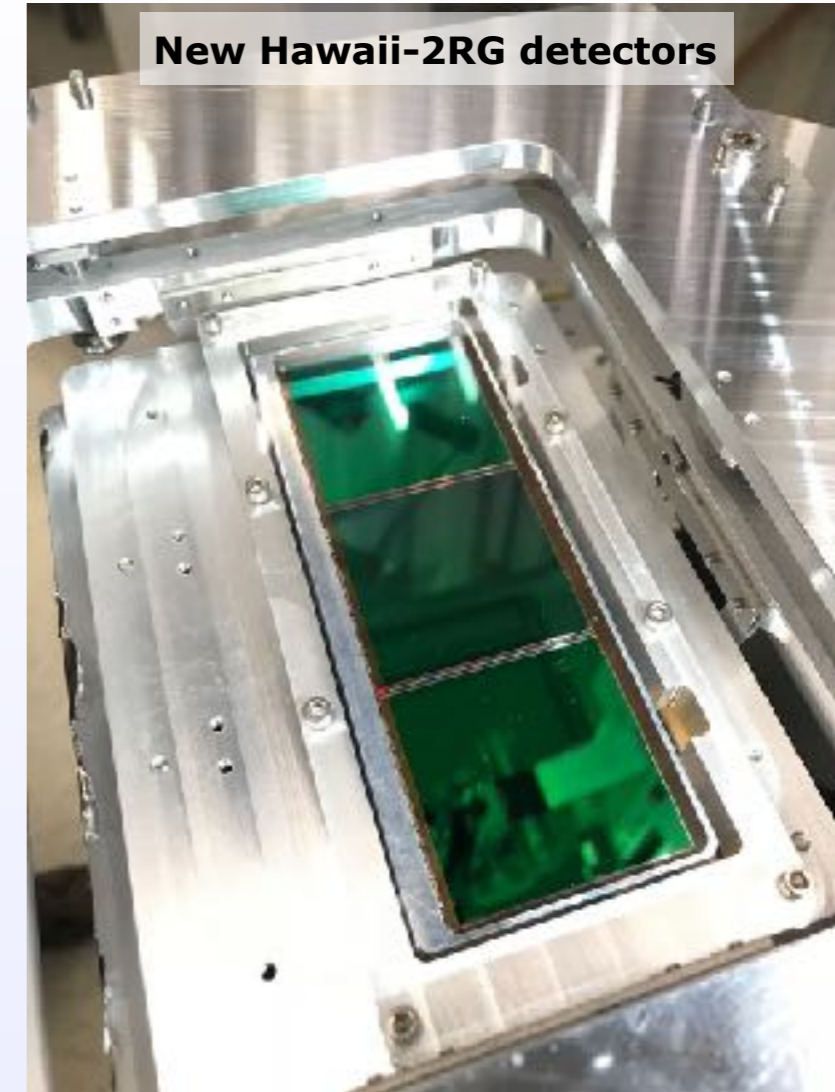

Spectropolarimetry with HiRISE?

- Not possible!
- Spectropolarimetric unit located inside the CSU

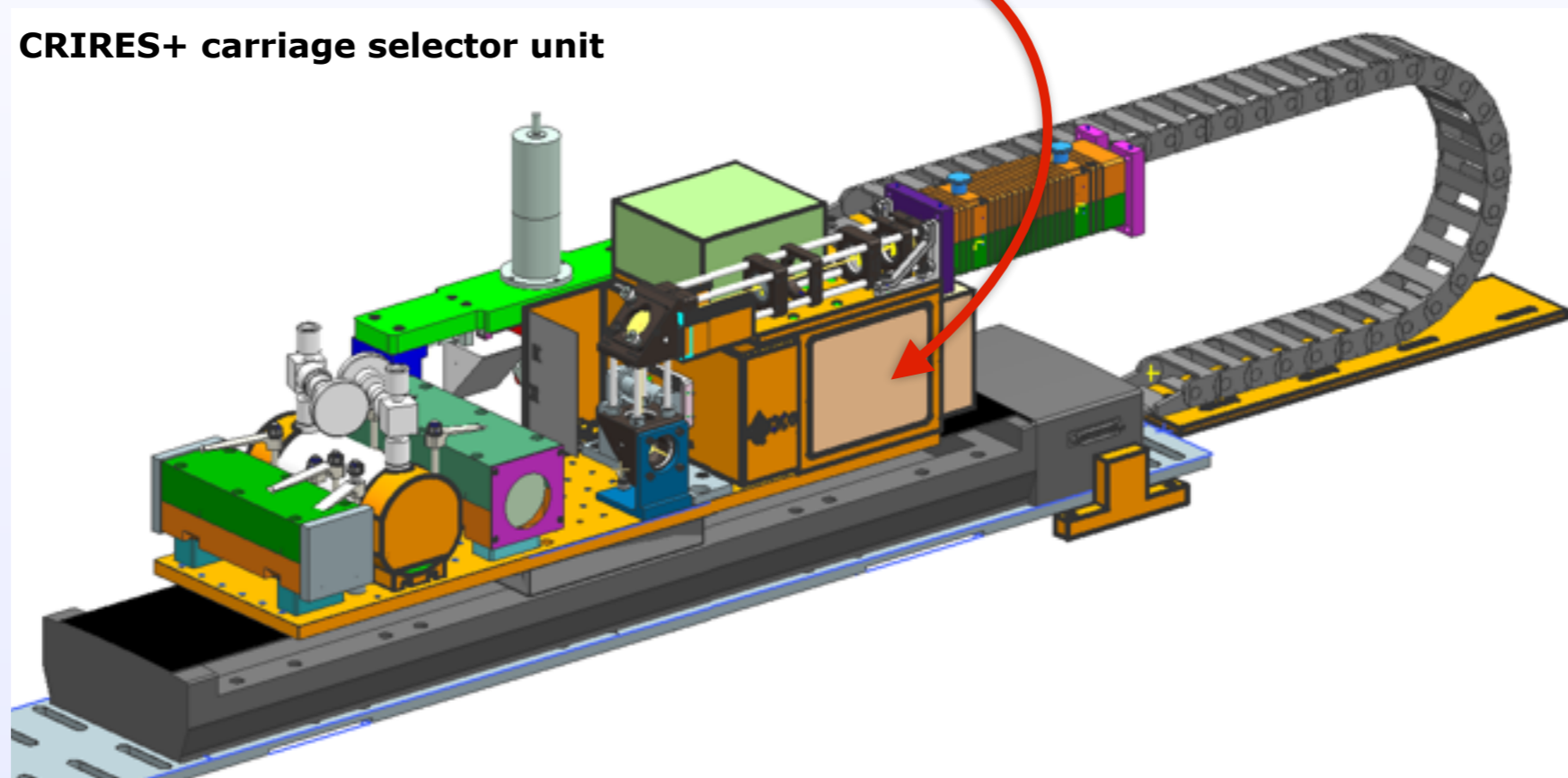

- Already photon-starved regime... every single photon counts!

Transmission budget

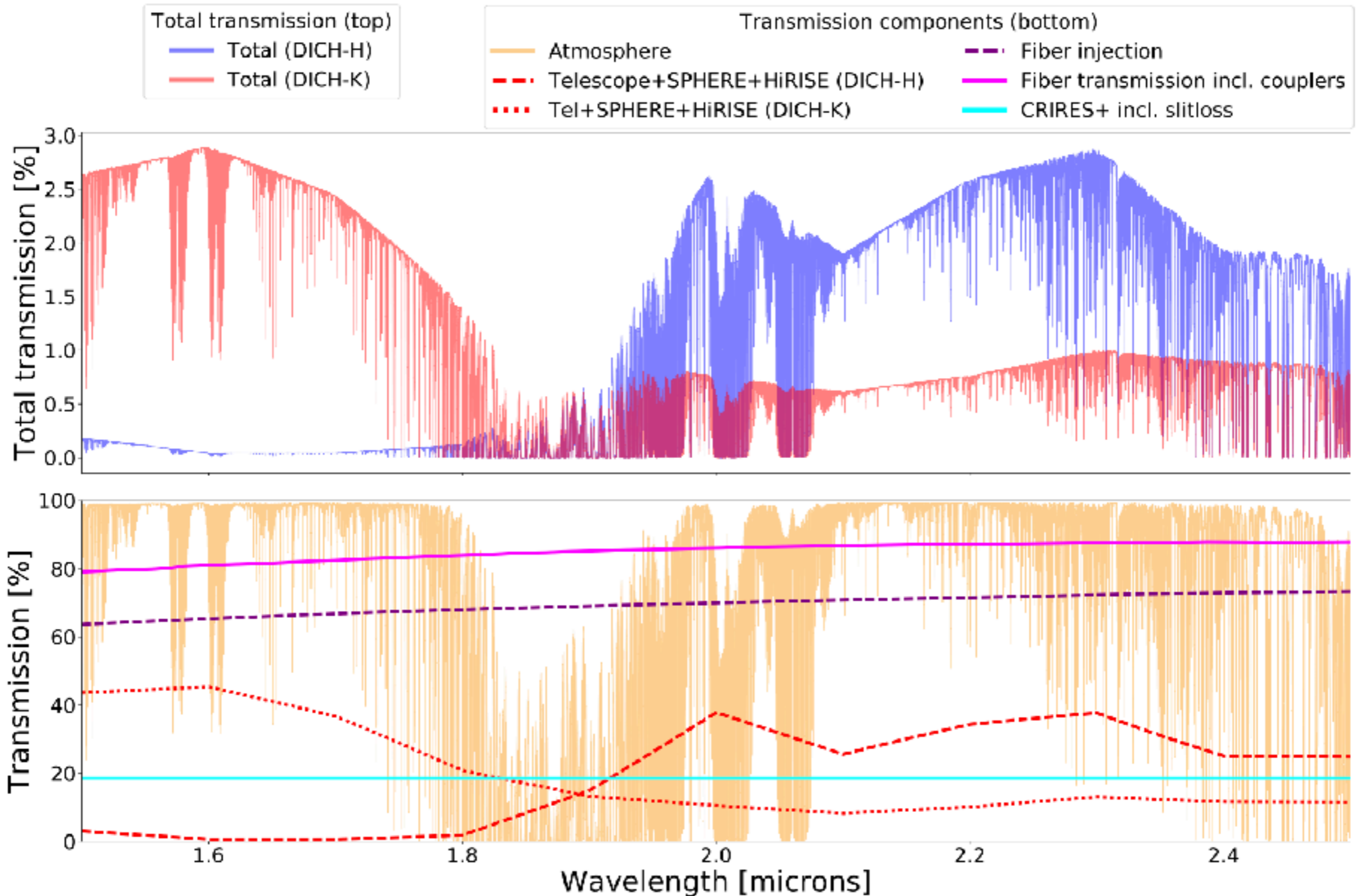

Do we really want a coronagraph?

- Baseline in SPHERE → apodized pupil Lyot coronagraph
- YES, from the injection efficiency point-of-view...

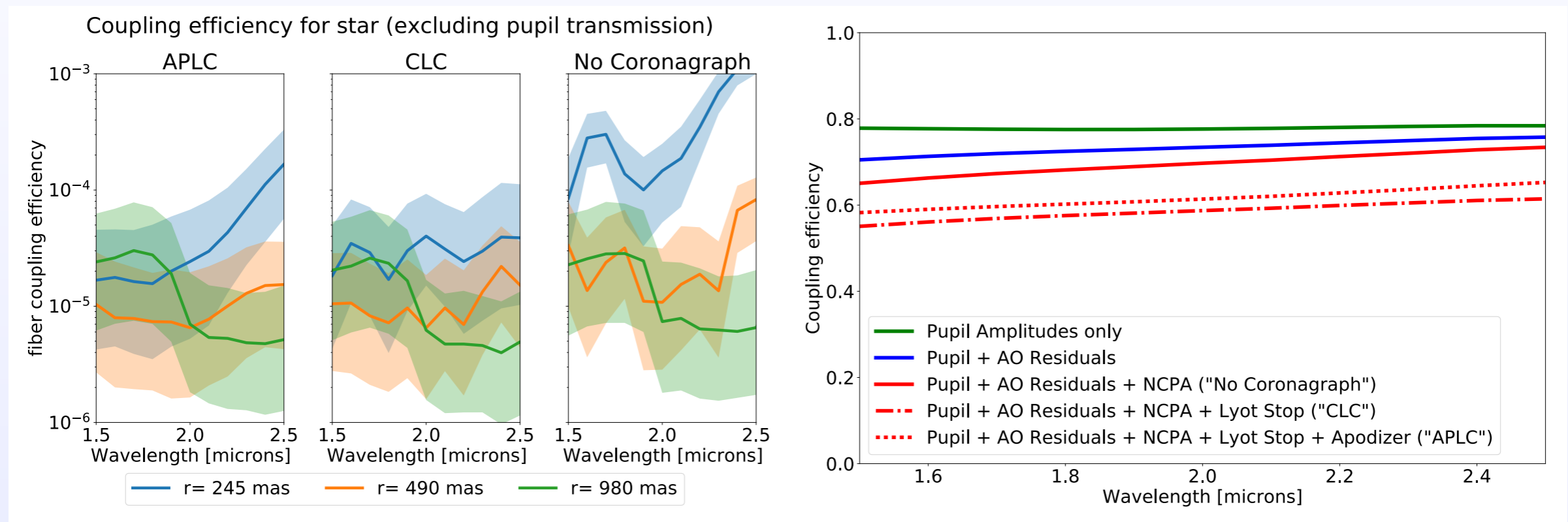

- ... but certainly not from the throughput point-of-view!

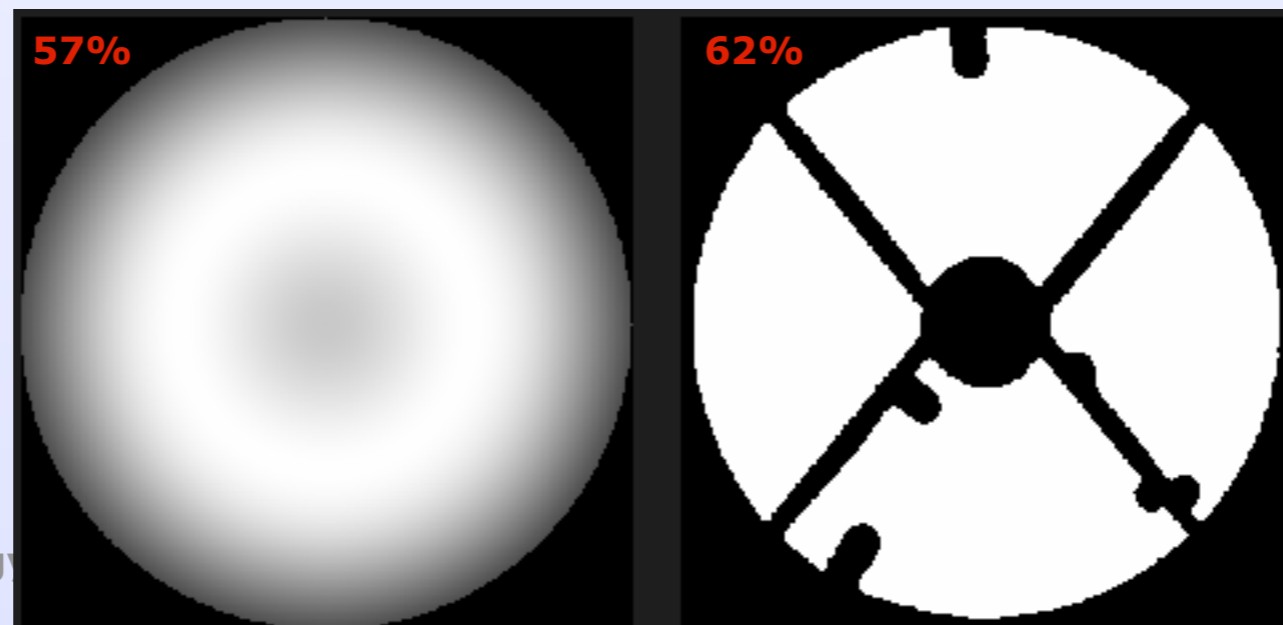

<40% of the total flux is transmitted!!

Performance estimation

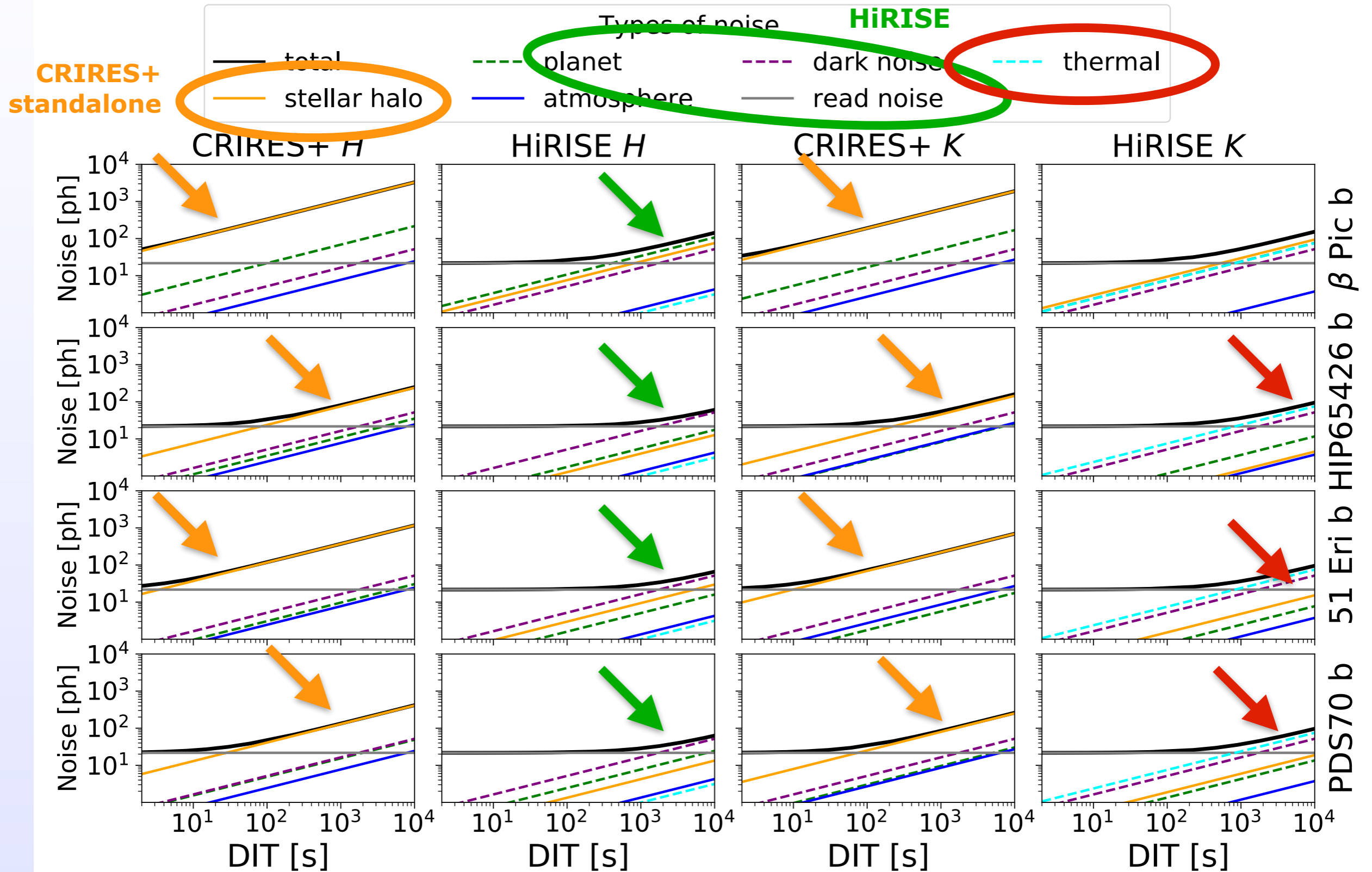

Performance estimation

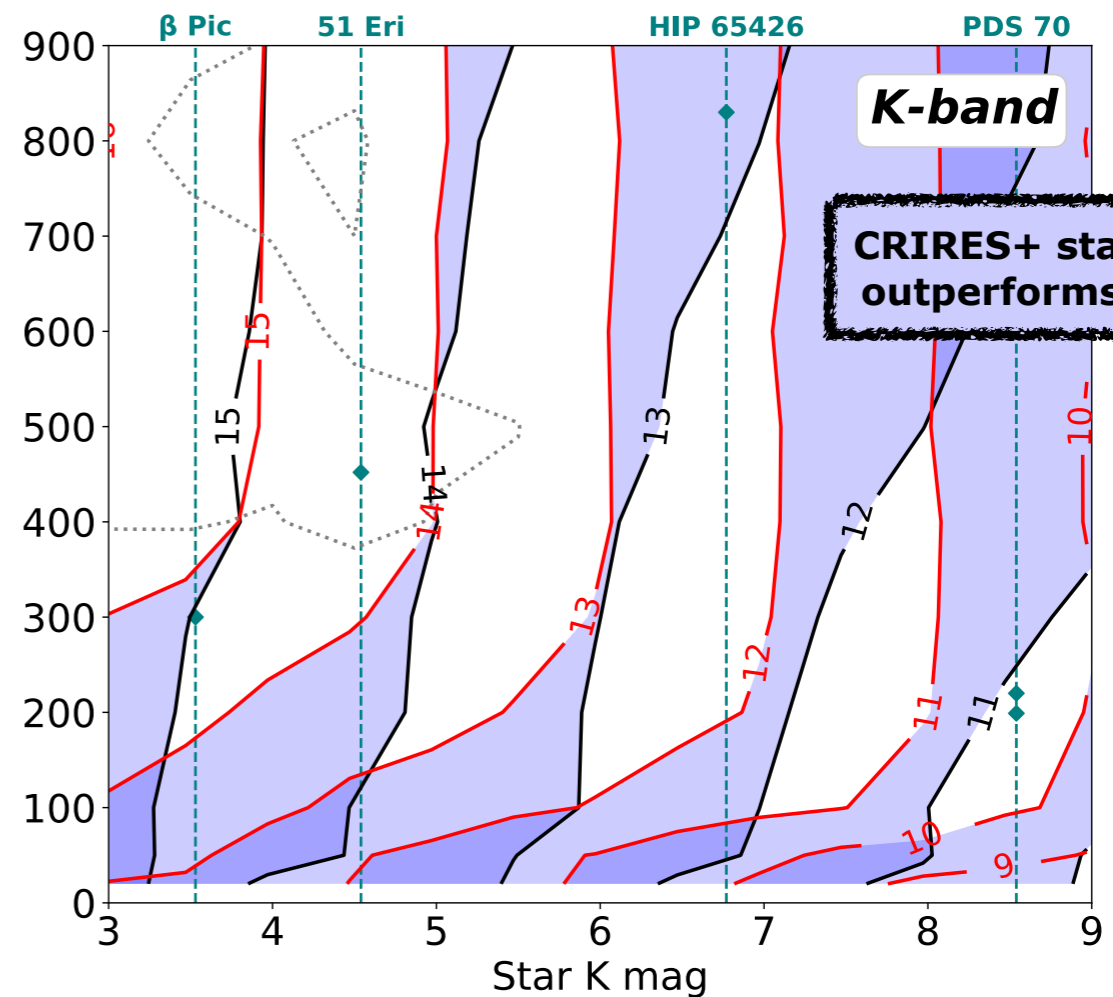
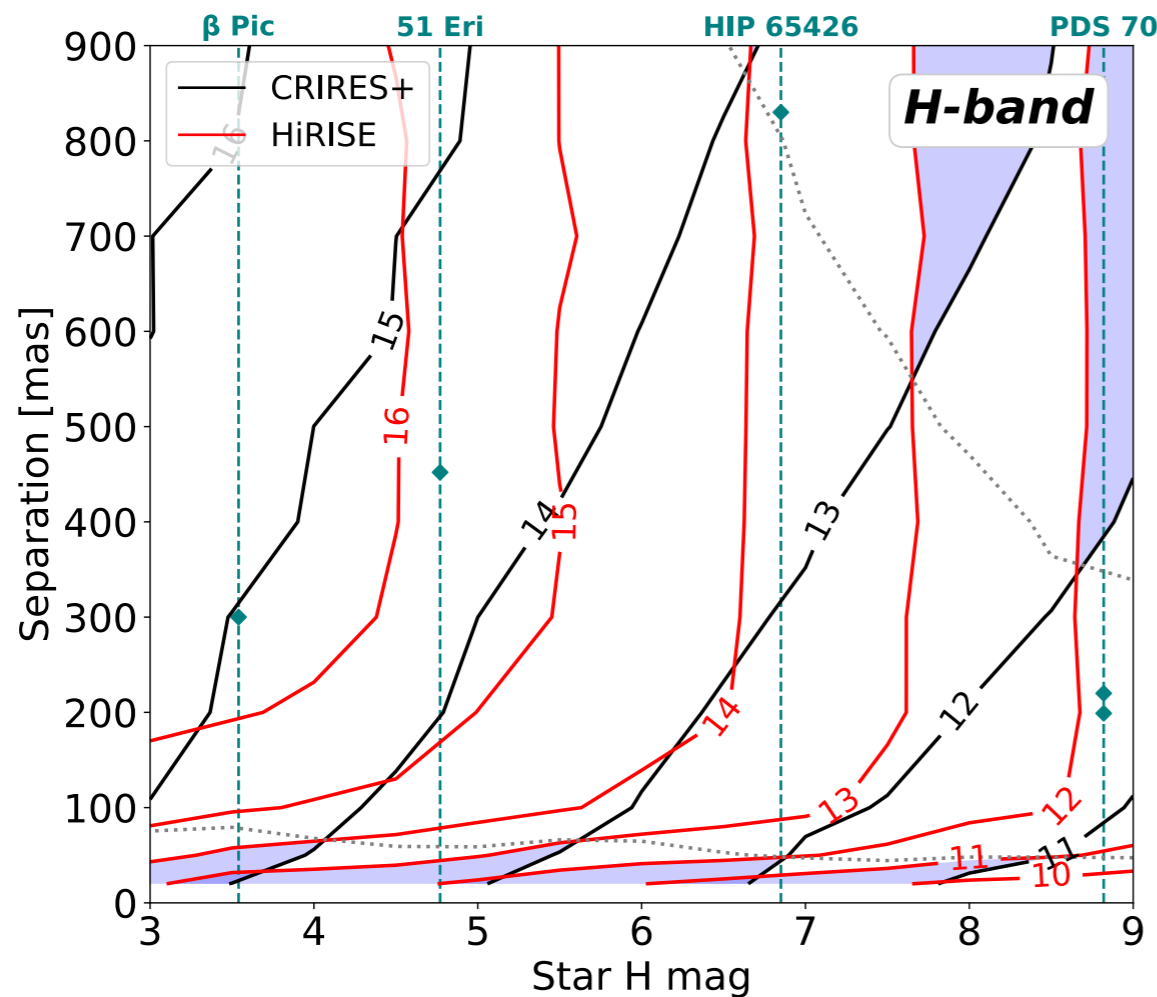
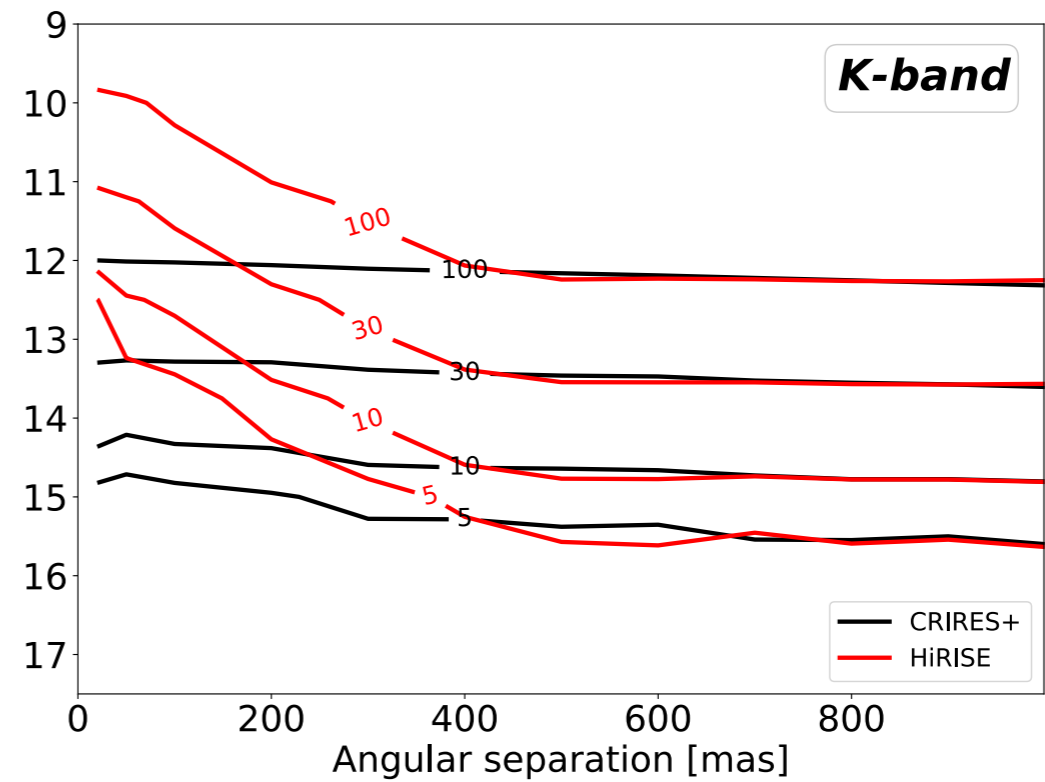
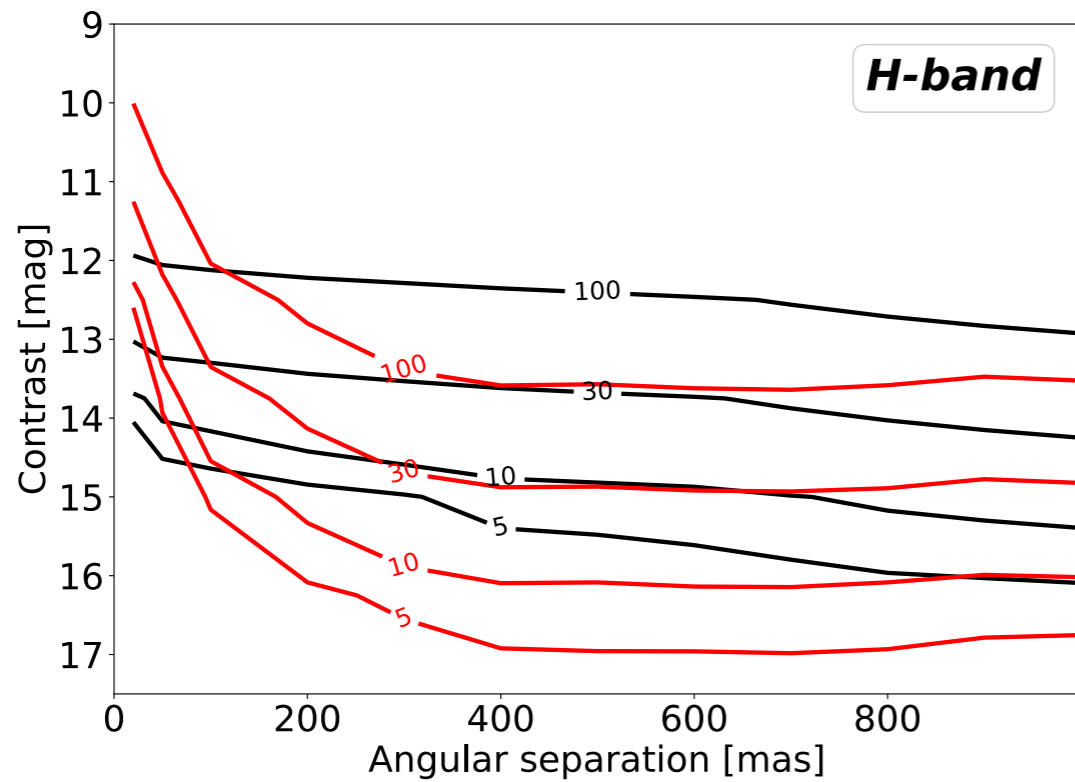

CRiRES+ standalone outperforms HiRISE

Expected performance

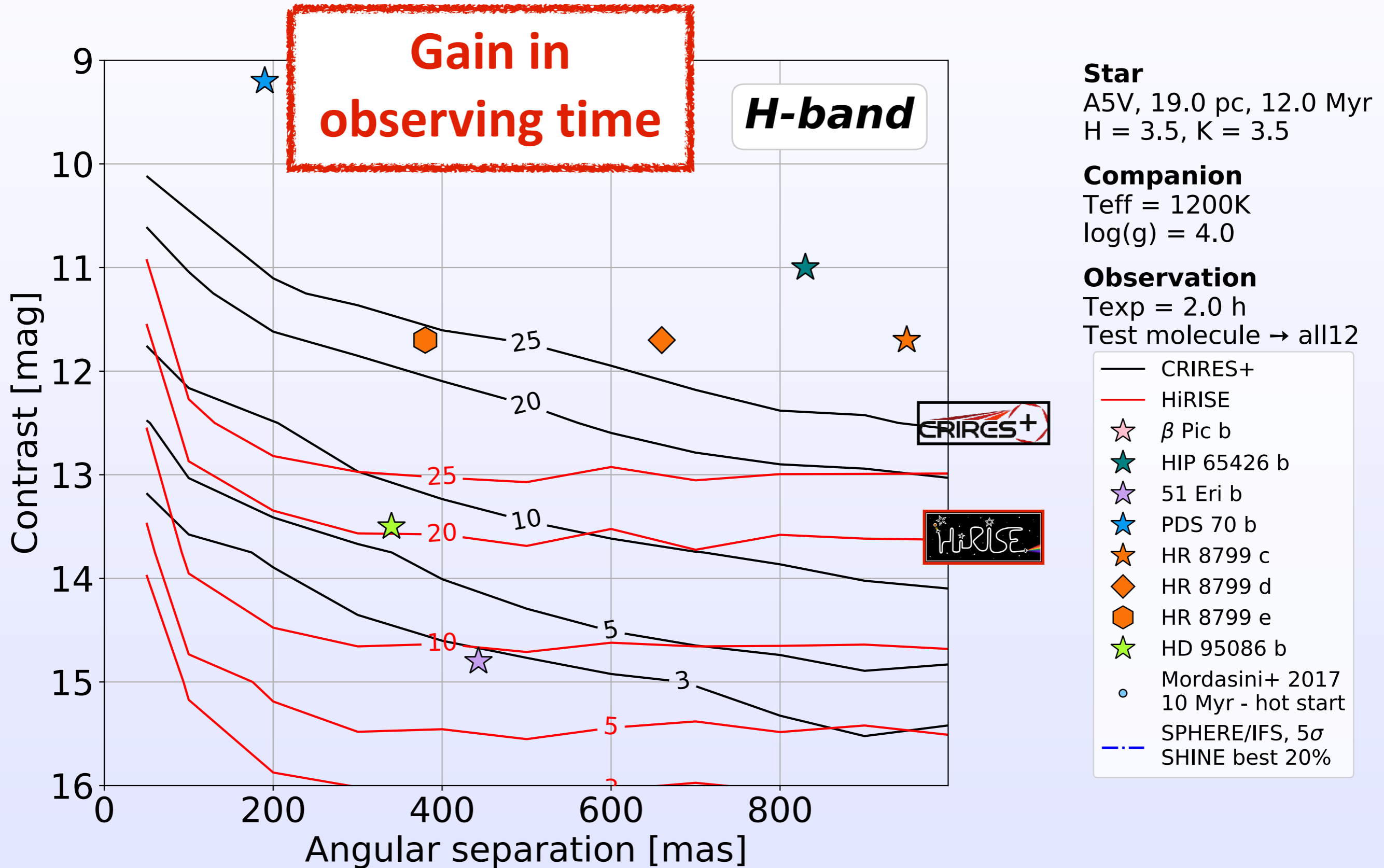

Expected performance

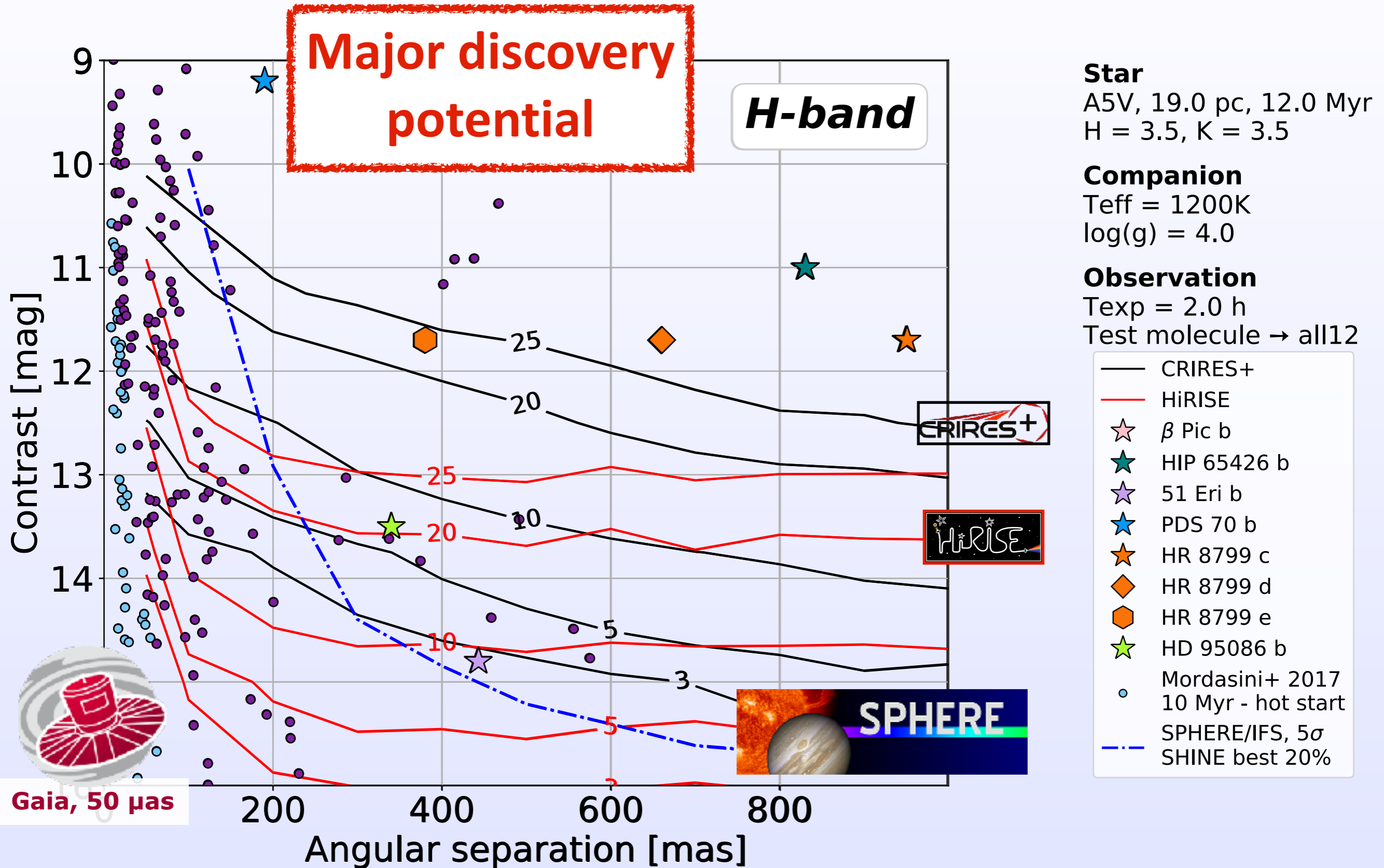

Status of HiRISE

- Many discussions with ESO over the past 2 years
- Science case validated by the OPC: **strong support!**
- Technical proposal validated by STC and Council: **strong support!**
 - **HiRISE accepted as a visitor instrument by Paranal**
- Current activities:
 - Final design
 - Identification of manufacturers
 - Procurement of some hardware
 - Laboratory validations
 - Design review with ESO Paranal

- Schedule:

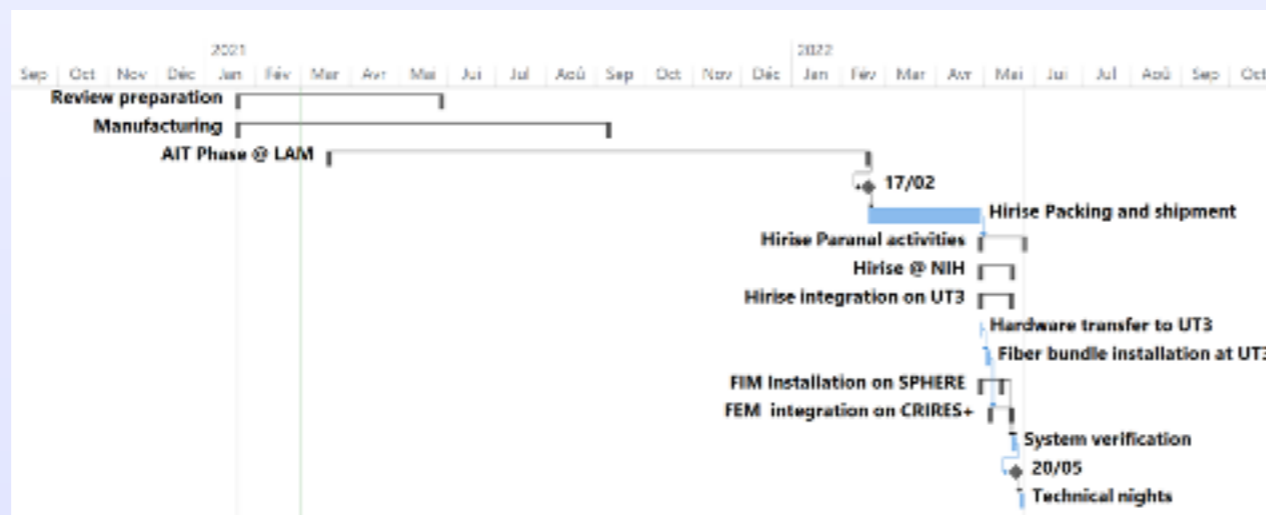

Technical activities

Laboratory validation on MITHiC

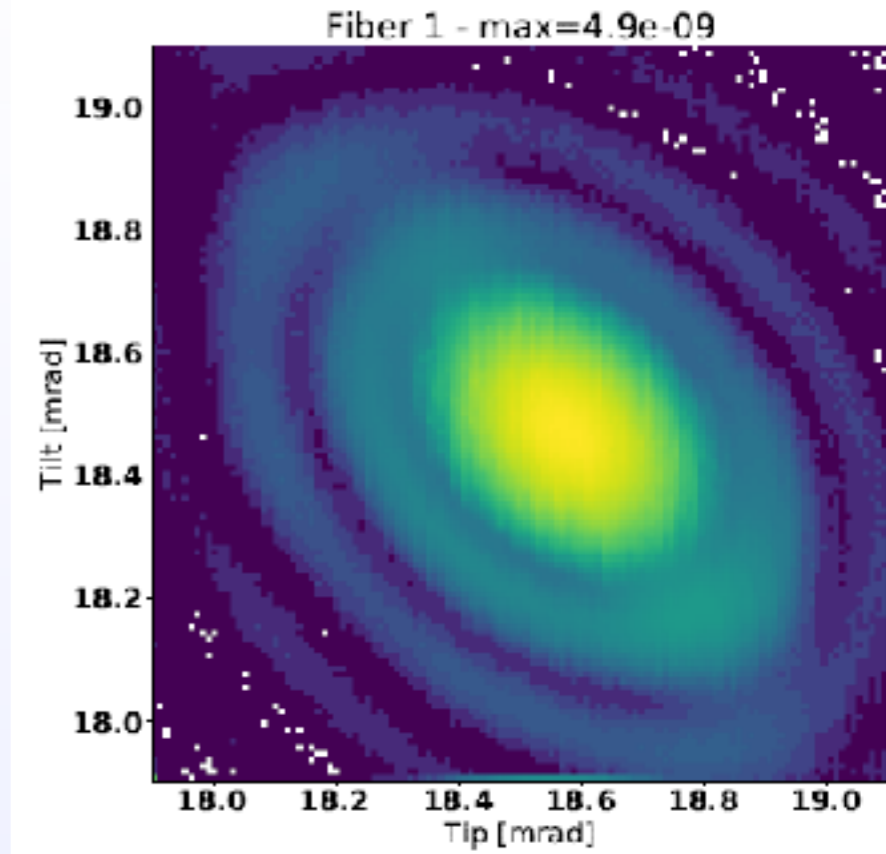
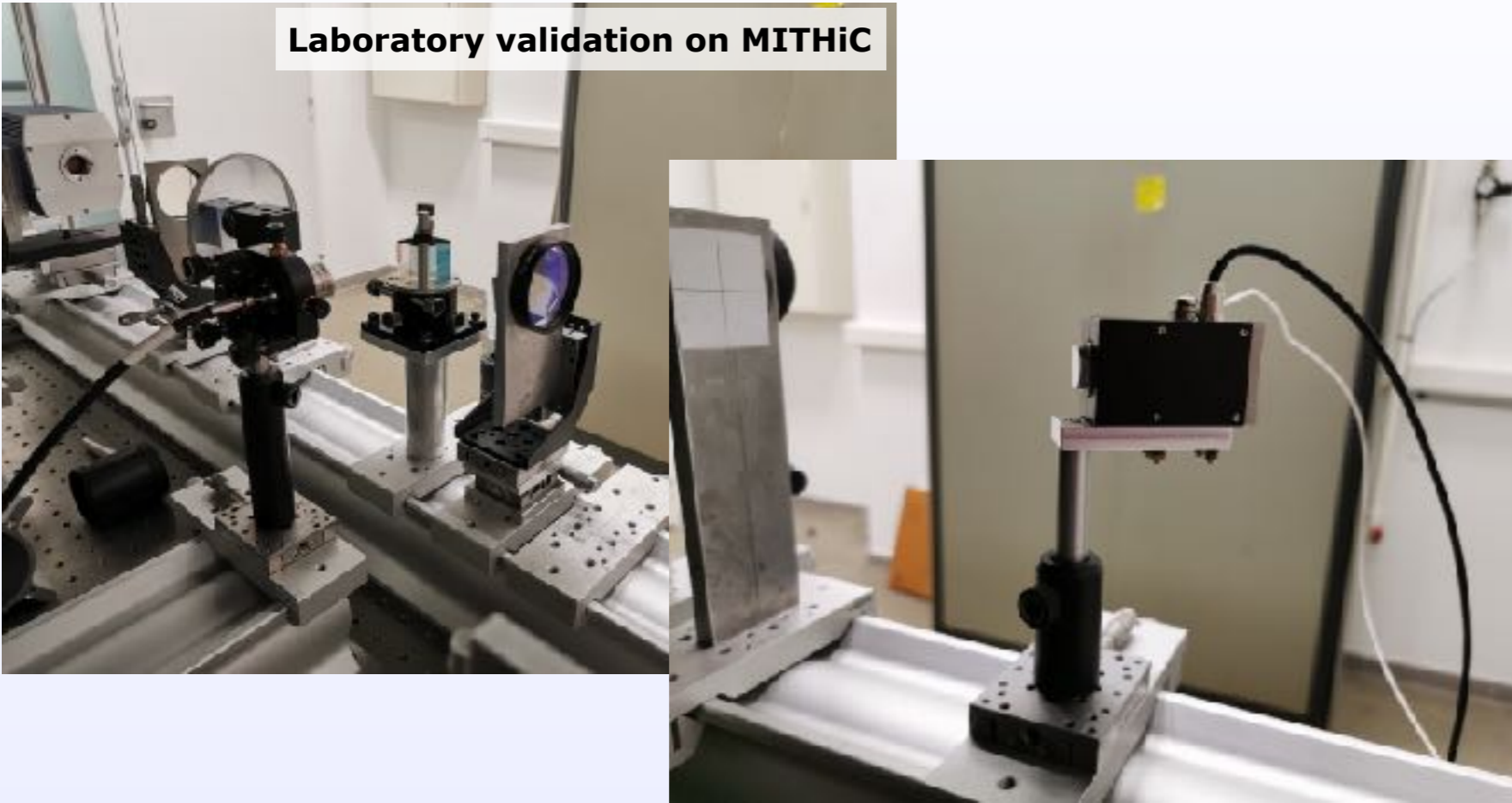

Fiber injection map

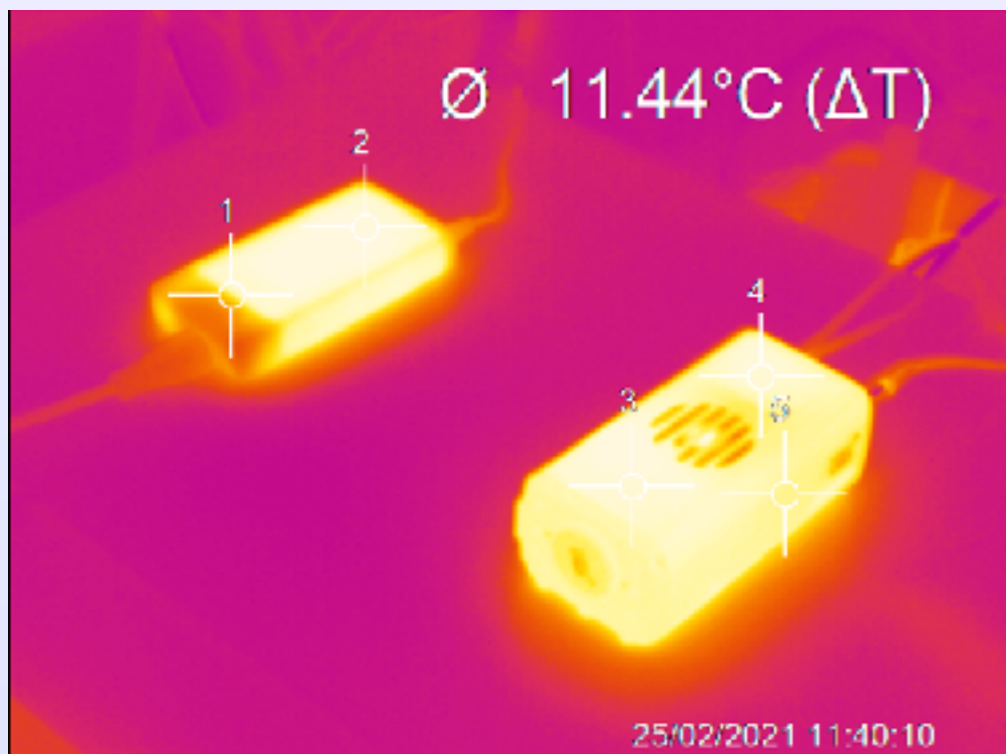

Conclusions

1. High spectral resolution on exoplanets

- Improved characterization
- Detection boost
- Opens new opportunities for understanding of exoplanets

2. HiRISE: high-spectral resolution of directly-imaged exoplanets

- Unique opportunity on VLT/UT3!
- Coupling between SPHERE and CRIRES+
- Final design on-going
- Accepted by ESO/Paranal as a visitor instrument
- On sky probably mid-2022
- Demonstrator for future instrumentation
ELT/PCS or post-JWST exoplanet imagers

HiRISE postdoc!



Preparation and analysis of the first on-sky data

<https://astro.vigan.fr/hirise.html>

